

Product Manual of TF02-Pro



www.benewake.com
Benewake (Beijing) Co., Ltd.



Specified Product

Product model: TF02-Pro

Product name: TF02-Pro LiDAR (Medium range sensor)

Manufacturer

Company name: Benewake (Beijing) Co. Ltd.

Address: No.28, Xinxu Road, Haidian District, Beijing, PRC

Copyright

The Copyright of this document is protected. All the rights involved herein belong to Benewake (Beijing) Co. Ltd. Any copy activity of this document, no matter in whole or in part, should be in conformity of the Copyright Law. The actives of Modification, omission or translation of this document are not allowed unless a written permission from Benewake (Beijing) Co. Ltd.

All rights reserved © Benewake (Beijing) Co. Ltd.

Product Certification





Foreword

Dear users,

Thanks for choosing Benewake products, and it's our pleasure to help you to solve any technical question.

In the purpose of offering a better operation experience to you, we hereby write this manual for an easier and simpler operation of our product, hoping to better solve the common problems you maybe meet.

This operation manual covers the product operation introduction and common problem solutions, but it is really hard to covers all the problems you maybe meet. So, if you have any further questions or problems, please feel free to consult our technical support service (support@benewake.com). We will do our best to solve any problem related to the product. If you have any other good advice or suggestion, welcome to visit our official website and offer us your feedback there (http://en.benewake.com/contact_us), and we are looking forwards to your participation.

We are Benewake who dedicated to making the best “Robotic Eyes” worldwide!

Table of Contents

1	Attentions	5
1.1	About this Manual	5
1.2	Usage of Product	5
1.3	Conditions with Potential Malfunction	5
2	Physical Interface	6
2.1	Description about Line Sequence	6
2.2	Electrical Characteristics	6
3	Appearance and Structure	7
4	Communication Protocol and Data Formats	8
4.1	Serial port Communication Protocol	8
4.2	Data Output Format of Serial port	8
4.3	Descriptions of default Output Data	9
4.4	I²C data communication	9
4.5	Timing sequence description of I²C mode	9
4.6	I/O mode description	9
5	Quick Test	10
5.1	Tools required for Product Test	10
5.2	Test Procedures	10
6	Descriptions on User-defined Parameter Configuration	11
6.1	Command Convention	12
6.2	General Parameter Configuration and Description	12
7	Remote upgrading	15
8	Malfunction: Causes and Troubleshooting	16
9	Q&A	18
	Attachment 1: Introduction of TF Series PC software	19



1 Attentions

1.1 About this Manual

- This manual provides all the essential information during the usage of this product.
- Please carefully read this manual and make sure that you fully understand everything herein.

1.2 Usage of Product

- The maintenance of this product should be done by the professional technician, and the product can only work with the factory spare part for ensuring the performance and safety.
- This product itself has no polarity and over-voltage protection. Please properly connect and supply power as described in this manual.
- Operating temperature of this product is between $-20^{\circ}\text{C}\sim 60^{\circ}\text{C}$. Do not use it beyond this temperature range to prevent malfunction.
- Storage temperature of this product is between $-30^{\circ}\text{C}\sim 80^{\circ}\text{C}$. Do not store it beyond this temperature range to prevent malfunction.
- For ensuring the product performance, do not open the product shell or remove the IR-pass filter.

1.3 Conditions with Potential Malfunction

- Detecting object with high reflectivity, such as the mirror or the smooth floor tile, may cause a system malfunction.
- The product will malfunction if there is any transparent object between it and the detecting object, such as glass or water.
- The product will be subject to risk of failure if its transmitting or receiving lens is covered by the dust. Please keep the lens clean.



2 Physical Interface

2.1 Description about Line Sequence

Type of external connecting terminal of TF02-Pro is 1.25-4p(Molex510210400).

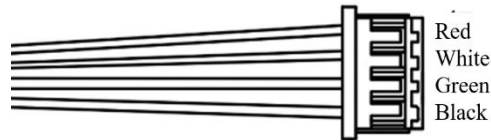

Table 1 The Function and Connection Description of each pin

Color	Function	Comment
Red	+5V	Power supply
White	RXD/SDA	Receiving/Data
Green	TXD/SCL	Transmitting/Clock
Black	GND	Ground

2.2 Electrical Characteristics

This product has no overvoltage nor polarity protection, so please make sure that connection and power supply are normal.

Table 2 Major Electrical Parameters of TF02-Pro

Description	Parameter value
Supply voltage	5V~12V
Average current	≤200mA
Peak current	300mA
Average power	≤1W
Communication level	LVTTL (3.3V)



3 Appearance and Structure

It is recommended to use M2.5 round Phillips screws for installation.

Please remove the protective film of the optical lens before use. The lens of front panel of LiDAR cannot be covered. Please keep it clean.

The surface of optical lens is the ranging zero of LiDAR.

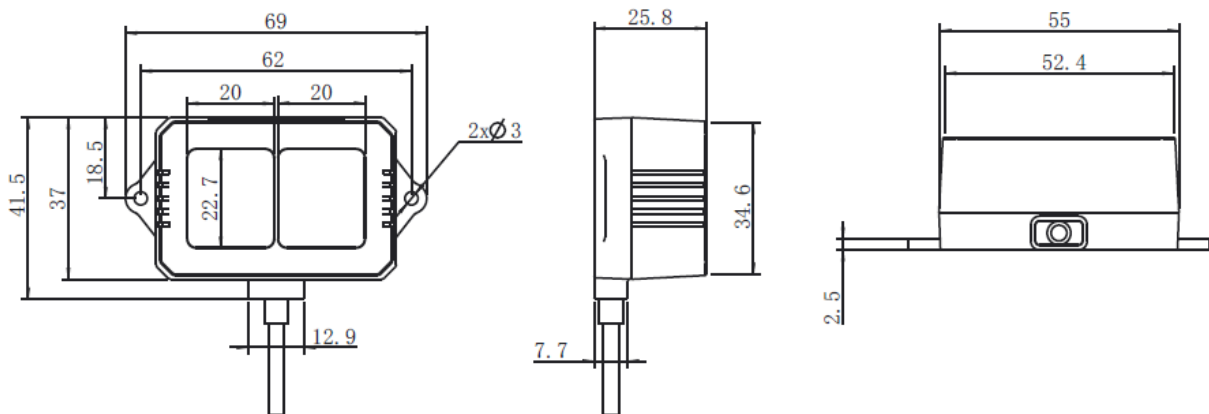

Figure 1: Constructional Drawing of TF02-Pro (unit: mm)

The detection angle of TF02-Pro is 3° . At different distances, the size of the spot, namely the edge length of the detection range, is different. Side length of the detection range at different distances (the detection range is a square), as shown in Table 3.

Note: The side length of the target object generally should be longer than that of the TF02-Pro detection range; if the side length of the detected object is shorter than that of the detection range, the output (Dist) from TF02-Pro will be a value between the actual distance values of the two objects.

Table 3: Edge length of spot detection range

Distance(m)	1	2	3	5	7	10	20	30	40
Edge length of detection range (cm)	5	10	16	26	37	52	105	156	208





4 Communication Protocol and Data Formats

4.1 Serial port Communication Protocol

TF02-Pro adopts the serial port data communication protocol, as given in Table 4.

Table 4: Data Communication Protocol of TF02-Pro——UART

Communication interface	UART
Default baud rate	115200
Data bit	8
Stop bit	1
Parity check	None

4.2 Data Output Format of Serial port

TF02-Pro is available with two formats of data output, namely, the standard data output format and the character string data format, both of which are switchable with command.

Standard data output format (default):

Data structure: each data frame contains 9 bytes, including the distance value, signal strength, temperature of chip and data check byte (Checksum), etc. Data format is hexadecimal (HEX). Data codes are detailed in Table 5.

Table 5: Data Format and Code Explanation

Byte0 -1	Byte2	Byte3	Byte4	Byte5	Byte6	Byte7	Byte8
0x59 59	Dist_L	Dist_H	Strength_L	Strength_H	Temp_L	Temp_H	Checksum
Data code explanation							
Byte0	0x59, frame header, same for each frame						
Byte1	0x59, frame header, same for each frame						
Byte2	Dist_L distance value low 8 bits						
Byte3	Dist_H distance value high 8 bits						
Byte4	Strength_L low 8 bits						
Byte5	Strength_H high 8 bits						
Byte6	Temp_L low 8 bits						
Byte7	Temp_H high 8 bits						
Byte8	Checksum is the lower 8 bits of the cumulative sum of the number of the first 8 bytes						

- **Character string data format**

The data output is in the format of character string and its unit is m(meter). For example, if the





measurement distance is 1.21m, the string 1.21 will be output, followed by the escape character '\r\n'.

4.3 Descriptions of default Output Data

Dist(Distance): Represents the output of the distance value detected by TF02-Pro, with the unit in cm by default. This value is interpreted into the decimal value in the range of 0-4500. When the signal strength is lower than 60, the detection is unreliable, TF02-Pro will set distance value to 4500. When the signal strength is larger than 60 and the actual distance is between 45 and 60 meters, the output value is 4500. When the signal strength is larger than 60 and the actual distance is more than 60 meters, there will be periodic data, in which case the data is 0 or other abnormal values.

Strength: Represents the signal strength with the default value in the range of 0-65535. After the distance mode is set, the longer the measurement distance is, the lower the signal strength will be; The lower the reflectivity is, the lower the signal strength will be.

Temp(Temperature): Represents the chip temperature of TF02-Pro. Degree centigrade = Temp / 8 -256

4.4 I²C data communication

TF02-Pro also supports I²C data communication interface, as shown in the table below:

Table 6: TF02-Pro data communication protocol—I²C

Interface	I ² C
Max transmission rate	400kbps
Mater/slave mode	Slave mode
Default address	0x10
Address range	0x01~0x7F

4.5 Timing sequence description of I²C mode

Different from the serial mode, the I²C communication is initiated by the master. TF02-Pro as the slave, can only send and receive data passively. After the sending the config-frame from the master to the slave, one needs to wait for a period for the command to be processed. Then read feedback operation, the suggested waiting period is 100ms. Data are detailed in Table 7.

Table 7: Timing sequence of the I2C mode

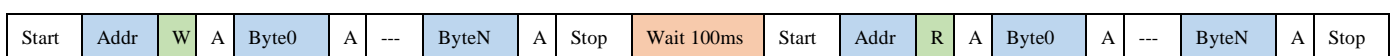

4.6 I/O mode description

I/O output mode is supported and could be enabled by related command. See detail in chapter 6.2. Command open mode(Mode),critical distance(Dist) and hysteresis zone(Zone) could be configurable:





Mode: 0 (data output mode), 1(I/O mode, low level near and high level far); default value is 0.





Dist: critical value, near end value in hysteresis zone, unit is cm, default number is 0.

Zone: hysteresis zone range, unit is cm; default value is 0 (there is no hysteresis zone).

The hysteresis zone could be set by this command, when output is near zone level, output will be switched to far zone level if measured result is higher than far end point; when output is far zone level, output is switched to near zone level if measured result is lower than near end point. (high level: 3.3V, low level: 0V.

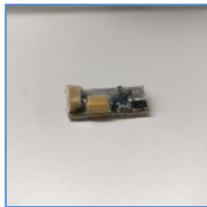
5 Quick Test

5.1 Tools required for Product Test

				
TF02-Pro	TTL – USB converter	USB cable	PC	PC Software

5.2 Test Procedures

① Download the Test software

Please download the Test software of TF02-Pro at our official website (en.benewake.com).

Caution: please shut down any anti-virus software before uncompressing the PC software. Otherwise, maybe the software is deleted as virus. The software is only runnable under Windows environment for the time being. Please refer to Attachment 1 - Product manual of TF Test software.

② Connection of the hardware

Connect “TF02-Pro”, “TTL - USB board” and “USB cable”. Make sure there is no loose connection. Then connect “USB cable” with “PC”.

③ Connection to the Test software and data output

④ Open the PC software and select “① TF02-Pro” and select automatically recognized occupied serial port (here it is “② COM9”), as shown in Figure 3.





- ⑤ Then click “CONNECT”. Upon successful connection, The continuous images of the output data will be displayed in area “④ TIME LINE CHART” on the right. Besides, the real-time data of the Current measure distance (Dist), effective data points per second (Effective Points) and signal strength (Strength) will be displayed in area “⑥ REAL TIME DATA” below.

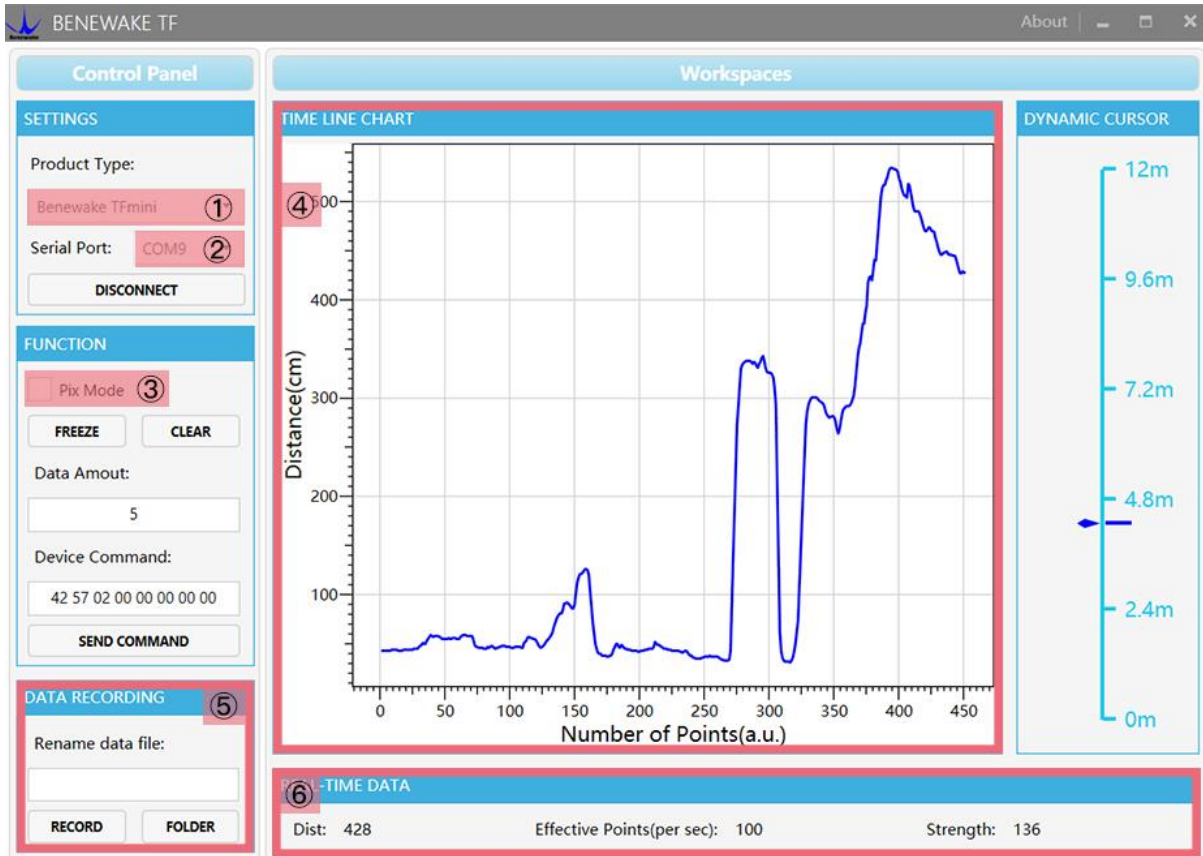

Figure 2: PC software Interface and Display

Notes:

- If no data is available in area “④TIME LINE CHART”, please check the line connection and line sequence. When TF02-Pro is successfully powered on, there will be a red indicator light inside transmitting lens viewing from the front.
- The value of distance output Dist may vary with the output unit, which is cm by default. If the unit of distance is changed to the unit-mm with specific command, and the PC software will be unable to identify it, and so the unit of “④TIME LINE CHART” will still be cm. For example, the actual TF02-Pro measurement is 1m, the distance value of TF02-Pro is 1000 in mm, the value read by the PC software also is 1000, but the unit will not change and still display cm.

6 Descriptions on User-defined Parameter Configuration

The function of user-defined configuration of product parameters is hereby enabled for more flexible



settlement of your problems by TF02-Pro. User may modify original parameters by sending relevant commands, such as output data format and frame rate, etc.

Please modify product configuration depending upon your actual demands. Do not frequently try irrelevant commands to prevent incorrect sending of command which many cause unnecessary loss. Please make sure to make the configuration as the commands listed herein. Do not send unstated command.

6.1 Command Convention

1) Multi-bytes data or command frame is transmitted in **little endian format**.

For example, decimal number 1000 can be transferred to 0x03E8 in hexadecimal. Then it will be saved in the data or command frame as:

0x5A 0x06 0x03 0xE8 0x03 0x4E

- 1) Command: data instruction frame sent from PC to LiDAR.
- 2) Response: data instruction frame uploaded from LiDAR to host computer or other terminal

6.2 General Parameter Configuration and Description

Before setting the relevant parameters of TF02-Pro, user needs to establish the connection between TF02-Pro and PC at first. User can send the relevant configuration-related instructions to the product via TF02-Pro PC software or other serial port debugging software. All commands are compatible with both the UART mode and the I²C mode. **Important: Configure the parameters in the following three steps.**

a) Enter configuration mode and send: AA 55 F0 00 01 00 00 02.

Response: AA 55 F0 00 01 00 00 02, which means successful transmission.

b) Configuration of product parameters: see Table 8;

c) Exit configuration mode and send: AA 55 F0 00 00 00 00 02.

Response: AA 55 F0 00 00 00 00 02, which means successful transmission.

Table 8: General Parameter Configuration and Description

Parameters	Command	Response	Remark	Default setting
Obtain firmware version	AA 55 F0 00 00 00 00 A0	AA 55 F0 00 00 XX YY ZZ	Version V XX.YY.ZZ	
System reset	AA 55 F0 00 FF FF FF FF	AA 55 F0 00 FF FF FF FF	No need to enter configuration mode	/
Frame rate	5A 06 03 LL HH 00	5A 06 03 LL HH SU	1-1000Hz ^①	100Hz





Trigger format	5A 05 07 01 00	5A 05 07 01 67	Timer trigger	√
	5A 05 07 00 00 5A 06 03 64 00 00	5A 05 07 00 66 5A 06 03 64 00 C7	Instruction trigger	/
Trigger detection	AA 55 F0 00 XX 00 00 42	AA 55 F0 00 XX 00 00 42 & Data frame	Effective in instruction trigger mode, no need to enter configuration mode; XX coverage[01,64]	
Output format	5A 05 05 01 65	5A 05 05 01 65	Standard 9 bytes (cm)	√
	5A 05 05 02 66	5A 05 05 02 66	String format(m)	/
	5A 05 05 06 6A	5A 05 05 06 6A	Standard 9 bytes (mm)	/
Baud rate	5A 08 06 H1 H2 H3 H4 00	5A 08 06 H1 H2 H3 H4 SU	Set baud rate ^② Example: 9600(DEC)=2580 (HEX) ,H1=80, H2=25,H3=00,H4=00	115200
Strength Threshold and Distance under threshold [®]	5A 07 22 XX LL HH 00	5A 07 22 XX LL HH SU	E.g. When strength is below 60, distance will be 4500cm. XX=60/10=6(DEC)=06(HEX) 4500(DEC)=1194(HEX) LL=94, HH=11	Threshold=60 Distance under threshold=4500
Enable/Disable output	5A 05 07 00 66	5A 05 07 00 66	Disable data output	/
	5A 05 07 01 67	5A 05 07 01 67	Enable data output	√
Communication interface setup	5A 05 0A MODE 00	/	0 (UART) 1 (I2C)	UART
Modify slave address of I ² C	5A 05 0B ADDR 00	Original instruction	Modify I2C_slave_addr	0x10
Obtain Data	5A 05 00 01 60	Data Frame(9bytes-cm)	Only works in I2C	/



Frame	5A 05 00 06 65	Data Frame(9bytes-mm)	mode	
I/O mode enable	5A 09 3B MODE DL DH ZoneL ZoneH 00	/	Open or close I/O output mode MODE: 0--standard data mode 1--I/O,near high and far low 2--I/O,near low and far high Zone:hysteresis zone	0 (Standard data format)
Restore factory settings	5A 04 10 6E	5A 05 10 00 6F	Succeeded	
		5A 05 10 01 70	Failed	

Note: 'SU' represents checksum.

- ① The default update rate is 100Hz. The customized update rate should be calculated by the formula: $1000/n$ (n is positive integer). Increasing frame rate will decrease the data stability.
- ② Only standard baud rates (9600/14400/19200/56000/115200/460800/921600) are supported. When setting a high update rate, a high baud rate is recommended to ensure data security.
- ③ If the threshold is less than 60, the distance will become unstable when the strength is below 60.
- ④ After sending parameter configuration command, please be sure to send the "exit configuration mode" command and wait for 1s, otherwise the setting will not take effect after recharging.
- ⑤ After sending "system reset" command, please keep the power on and wait for 1s, otherwise the reset may not take effect.





7 Remote upgrading

TF02-Pro supports the remote upgrade. When the user's product cannot satisfy the current application requirements and Benewake official website has relevant firmware upgrades, the user may upgrade the product firmware via remotely upgrading the PC software. Please contact us to get the Updater.

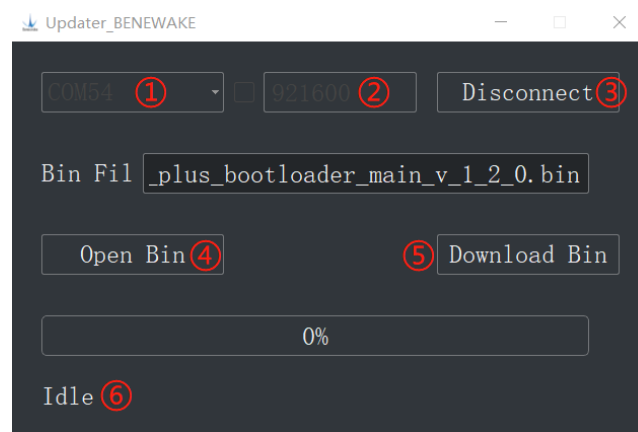

Figure 3: Firmware Upgrade PC software of TF02-Pro

The tools for the firmware upgrade of TF02-Pro are mostly the same as the [Quick Test](#), which requires one TTL-USB board to connect the TF02-Pro with PC.

Upon successful connection, open the Updater.exe. Select right port, here is “①COM54”. Input the right baud rate in “② 115200” and click “③ CONNECT” to connect the TF02-Pro with the Updater. Click “④ Open Bin” to choose the updating firmware, whose directory will be showed in the textbox above. Then click “⑤ Download Bin” to start upgrading. The information of upgrading will be showed in “⑥”.

Note: Remote upgrade of the host computer and firmware files need to be placed in the pure English path.





8 Malfunction: Causes and Troubleshooting

(1) Distance value occasionally will abruptly change into 4500 beyond the range during normal operation.

Cause: The different test environments (reflectivity of detected object, disturbance of ambient light, etc.) will affect the signal strength of TF02-Pro. For a reliable and stable measurement data, the algorithm elimination is internally used for TF02-Pro. In case of the insufficient signal strength, TF02-Pro will output 4500. This value is not measurement data of TF02-Pro, which is only used to remind the user that such data is unreliable.

Troubleshooting: please use such value as the trigger signal of some unreliable data, and it will ensure that your system can use other reliable data for further assessment and decision-making if there are some unreliable data.

(2) Significant error between the output distant value of LiDAR and actual distance

Cause ①: Incorrect interpretation of the data communication protocol of TF02-Pro.

Troubleshooting: check data communication interpretation means. In case of such error, please check the data format to adjust interpretation means.

Cause ②: Due to the physical principles of TF02-Pro, the above phenomenon is likely to occur if the detection object is the material with high reflectivity (such as mirror, smooth floor tile, etc.) or transparent substance (such as glass and water, etc.)

Troubleshooting: Please avoid use of this product under such circumstance in practice.

Cause ③: The IR-pass filters are blocked.

Troubleshooting: please use dry dust-free cloth to gently remove the foreign matter

(3) No data output

Cause: The product will be strictly inspected before leaving our factory, ensuring that all the shipped products can work normally. However, some abnormal working matters maybe still occur because of incidents during the transportation or use.

Troubleshooting: Check whether the power supply is normal; check whether the voltage is within rated voltage range. If power supply is normal, there will be a red light inside the transmitting lens of TF02-Pro.

Check TF02-Pro with correct connection sequence and reliable connection.



Check whether the data interpretation is correct. Please carry out the interpretation as per the data format specified herein.

(4) There is no data output when LiDAR is connected to PC software.

Cause ①: The PC software only supports the Windows operation system for the time being

Troubleshooting: Use the PC supporting Windows operation system.

Cause ②: TTL - USB board is poorly connected.

Troubleshooting: Check the TTL -USB board with the correct and reliable connection with TF02-Pro and PC.

Cause ③: Driver of serial port is not correctly installed.

Troubleshooting: Plug and unplug USB cable again. Try to reinstall the driver or directly download and install a driver from the internet.

If the PC software still work abnormally, please contact our technical support.

(5) The accuracy of TF02-Pro gets worse at 40m of white board and the data fluctuation becomes larger.

Cause: There are metal objects around the front lens barrel.

Troubleshooting: Remove or replace metal objects near the lens barrel with non-metallic materials. If the metal material around the lens barrel in your installation position cannot be changed, and there are high requirements for data stability and error at the extreme distance, please contact our technical support.



9 Q&A

Q1: Is TF02-Pro available with 3.3V or other power supply voltage?

A1: Sorry, it is not available for the time being. The Standard power supply of TF02-Pro is 5V~12V. If you have any further requirement, please contact our sales person to consult a customization design matter.

Q2: TF02-Pro will heat up after operating for a while. Is it broken?

A2: This is the normal operating condition of the product. The temperature of the chip and circuit board will slightly up after a continuous operation, which is a normal case.

Q3: Can TF02-Pro be connected with Arduino or Raspberry Pi for use?

A3: Yes, it can. TF02-Pro adopts serial communication protocol so that it can connect to any control board supporting serial port communication.

Q4: Is there error value in blind zone?

A4: No, but when you cover the front window completely, the distance will become 4500 because the strength is below 60.

Q5: What's the feature of distance when the signal is overexposed or insufficient?

A5: When the signal is overexposed under high reflectivity, strength value is 65535 and distance will become 0cm. When the signal is insufficient, strength value is less than 60 and distance will become 4500cm.

Q6: What's the outdoor performance of TF02-Pro?

A6: We have tested TF02-Pro under 10% reflectivity and 75KLux sunshine environment, it can reach 14m which is almost same as indoor.

Q7: Is there any way to extend the life of TF02-Pro?

A7: Yes, we recommend external trigger mode.

Q8: What's the meaning of Temp in the data? Is this temperature of environment?

A8: Temp is meaning the temperature inside TF02-Pro, it's a little higher than the temperature of environment.



Attachment 1: Introduction of TF Series PC software

This PC software only supports the Windows operating system. It is suitable for any products of TF series, but the output of those products is limited to the serial port communication protocol. Detailed operations are as below.



Figure 1: Interface of TF Series PC software

1 Product Type/Serial Port Control Zone [SETTINGS]

Product Type: connect the LiDAR via TTL-USB board to the PC. As shown in the figure, select 'TFmini'.

Serial port (COM): select the right serial port number corresponding to the LiDAR. Baud rate is set to 115200 as default.

CONNECT/DISCONNECT: Click [CONNECT] button to establish the connection with LiDAR. Click [DISCONNECT] button to terminate the connection.

2 Function Zone [FUNCTION]

Pix Mode: check the checkbox to enable Pix mode. Uncheck the checkbox will set TF02-Pro to default output format. **In Pix mode, the frame rate (Effective Points) calculated by test software is unreliable.**

FREEZE/CLEAR: After clicking [FREEZE], time-line chart in zone [4] will stop updating. On clicking



[CLEAR], the plotted curve in [4] will be cleared.

Frame Rate: choose frame rate from the drop box, setting will be made immediately.

Drawing/Pt: upon receipt of every N frames, the PC software will draw one point on the chart [4] the average of the N data. N can be modified depending upon the actual requirement (the value is preferable to be ≥ 10 to prevent the PC software from lagging). After entering the value, press “Enter” key on the keyboard to enable the setting.

Command: Input the commands in hexadecimal format in the text box and click the [SEND] button above to send the command.

3 Data Recording Zone [DATA RECORDING]

Input the name of data file in the textbox. Press [RECORD] button to start recording data and click the [FINISHED] button to stop recording. Click [FOLDER] button to open the folder where the data file is saved.

Note: when the frame rate of LiDAR is too high, like 1000Hz, the time stamp will be asymmetric due to the massive data stream.

4 Time Line Chart Zone [TIME LINE CHART]

The PC software will draw the continuous distance measurement curves based on the received data, where y-coordinates represent the current distance data while x-coordinates represent effective data.

5 Real-time Data Display Zone [REAL-TIME DATA]

Dist: Distance, cm by default.

Dist(Echo): parameter of TF03. With TF02-Pro, the default value is 0.

Effective Points (per sec): indicates effective points refreshed by TF per second (equals to frame rate).

Strength (Signal strength): in pix mode, TF02-Pro will not output strength value, so the Strength is 0 by default.

6 Operating Environment and Precautions

Operating Environment: this software can only run on Windows system, Win7 and above. The .Net Framework 4.5.2 is needed to use this software.

Precautions: Please do not directly connect the product with frame rate more than 500Hz to test software, which will make the UI unresponsive.