

MATRICE 350 RTK

Maintenance Manual v1.0

2024.03

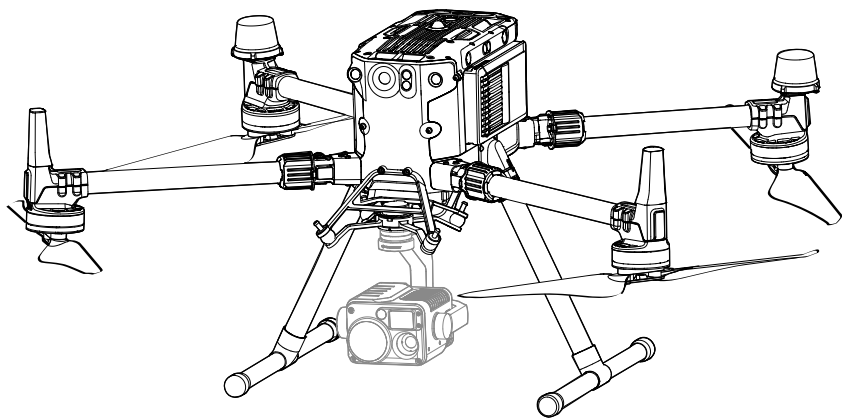



This document is copyrighted by DJI with all rights reserved. Unless otherwise authorized by DJI, you are not eligible to use or allow others to use the document or any part of the document by reproducing, transferring, or selling the document. Users should only refer to this document and the content thereof as instructions to operate DJI UAV. The document should not be used for other purposes.

Searching for Keywords

Search for keywords such as “battery” and “install” to find a topic. If you are using Adobe Acrobat Reader to read this document, press Ctrl+F on Windows or Command+F on Mac to begin a search.

Navigating to a Topic

View a complete list of topics in the table of contents. Click on a topic to navigate to that section.

Printing this Document

This document supports high resolution printing.

Contents

Introduction	2
Disclaimer	2
Safety Guidelines	2
Flight Condition Requirements	2
Storage and Transportation	3
Firmware Updates	3
Inspection and Maintenance	3
Routine Inspection	3
Regular Maintenance	8
After-Sales Service	17
Warranty Policy	17
Repair Channel	17
Appendix	18
Maintenance Record	18

Introduction

This Maintenance Manual offers guidelines to help you in the daily upkeep and maintenance of your aircraft. A record table is also included to help you keep track of the maintenance records throughout the product lifecycle.

This document will focus on the maintenance instructions and the notes, cautions, and warnings during use. Read the User Manual and Maintenance Manual carefully to optimize your user experience. If you have any questions on the maintenance operations, please contact DJI Support.

Disclaimer

Carefully read this entire document and all safe and lawful practices provided by DJI™ before using this product for the first time. Failure to read and follow instructions and warnings may result in serious injury to yourself or others, damage to your DJI product, or damage to other objects in the vicinity. By using this product, you hereby signify that you have read this disclaimer carefully and that you understand and agree to abide by all terms and conditions of this document and all relevant documents of this product. You agree to use this product only for purposes that are proper. You agree that you are solely responsible for your own conduct while using this product, and for any consequences thereof. DJI accepts no liability for damage, injury, or any legal responsibility incurred directly or indirectly from the use of this product.

DJI is a trademark of SZ DJI TECHNOLOGY CO., LTD. and its affiliated companies. Names of products, brands, etc., appearing in this document are trademarks or registered trademarks of their respective owner companies. This product and document are copyrighted by DJI with all rights reserved. No part of this product or document shall be reproduced in any form without the prior written consent of or authorization from DJI.

This disclaimer is available in various languages. In the event of divergence among different versions, the English version shall prevail. The final interpretation of this document and all related documents of this product belongs to DJI. This content is subject to change without prior notice. For up to date product information, visit <http://www.dji.com> and click on the product page for this product.

Safety Guidelines

Flight Condition Requirements

Operational Requirements

Before use, read the Disclaimer and Safety Guidelines, User Manual, and Maintenance Manual carefully.

Flight Restrictions

1. Please connect your aircraft to the internet to update the database of DJI GEO Zones regularly. Consult the relevant local government agencies or governing bodies before flight to ensure you comply with all the relevant laws and regulations.
2. If flying in GEO Zones is required, apply for unlocking in advance.
<https://www.dji.com/flysafe>

Storage and Transportation

There are safety requirements for the storage and transportation of the Intelligent Flight Batteries. Please strictly follow these Intelligent Flight Battery Safety Guidelines.

Firmware Updates

To optimize your experience, it is recommended to keep the firmware of the aircraft and remote controller up to date before each flight. Refer to the User Manual for instructions on running a firmware update.

If the firmware update fails, restart the device and retry. If the problem persists, please contact DJI Support.

Inspection and Maintenance

Routine inspection before and after operations or regular maintenance can greatly improve the aircraft's reliability, reduce potential safety hazards, and extend its service life.

Routine Inspection

It is recommended to check the following before each flight.

Checklist When Powered Off

Type	Essentials
Structure	<ol style="list-style-type: none"> 1. Visually inspect and use your fingers to feel the propellers, frame arms, arm junctions, and landing gears to check if they are in good condition. If there are any cracks or damage, replace the component immediately. ※ 2. The screws for all the connection structures are securely tightened, especially those for the arm junctions and battery locker. 3. The waterproof rubber port covers are in place. If not, water may enter the aircraft body which will cause short circuit. 4. There is no blockage in the intake vent of the upper cooling fan.
Motors	<ol style="list-style-type: none"> 1. The propellers are not visibly deformed, damaged, aged or softened. If they are, replace the propellers immediately. If there are any foreign objects on the propellers, clear them before use. ※ 2. Rotate the motors manually to check if they are firmly installed without a gap between the motors and the motor base and the motors rotate smoothly without noise. 3. Propellers are mounted correctly. CCW propellers should be on motors 1 and 3, and CW propellers should be on motors 2 and 4. (The front-facing propeller on the right is motor 1, with motor 2, 3, and 4 arranged in a counter-clockwise order.) 4. Refer to the propulsion system section in the Regular Maintenance Items.

Batteries	<ol style="list-style-type: none"> 1. There is no foreign object in the battery ports on the aircraft and the ports are not misshapen. 2. The battery locker is secure and will not come loose during flight. 3. The battery shell has no visible damage. If it does, DO NOT use the battery for flight.
Antennas	<ol style="list-style-type: none"> 1. All the antennas on the aircraft and remote controller are tightened firmly and free of damage. They are in a place that will give the propellers proper clearance.
Gimbal (Payload)	<ol style="list-style-type: none"> 1. The gimbal appears intact and can rotate smoothly in all the three axes. 2. The lens is clean.
Radar (Payload)	<ol style="list-style-type: none"> 1. There is no blockage. The shell of the radar has no damage. The mounting bracket is secure and in good condition.
Remote Controller	<ol style="list-style-type: none"> 1. The control sticks are centered in neutral position, with no foreign object such as sand and soil, and can smoothly reach full ranges of motion in all channels. 2. The screen on the remote controller is clean and dry.
Damping Plate	<ol style="list-style-type: none"> 1. The dampeners and gimbal anti-drop rope are not damaged. The damping plate has no crack or split. The gimbal connector is secure and cannot be rotated in the opposite direction after the gimbal is installed.
Infrared Sensing and Vision Systems	<ol style="list-style-type: none"> 1. There is no blockage in the working range of the Infrared Sensing and Vision Systems and auxiliary lights, especially when using a non-DJI payload or accessory. 2. Check the lenses or glass of the Infrared Sensing and Vision Systems and auxiliary lights. <ol style="list-style-type: none"> a. Make sure there are no stickers or any other obstructions over the Infrared Sensing and Vision Systems. b. Clean the lenses and glass with a dust-free cloth if there is any moisture, fingerprint, or dirt. c. Contact DJI Support if there is any damage to the lenses of the Infrared Sensing and Vision Systems.
Emergency Supplies	<ol style="list-style-type: none"> 1. Spare USB-C cables 2. Two pairs of spare landing gears 3. Two pairs each of spare CW and CCW propellers 4. Spare microSD cards 5. Screwdrivers, screws of all types used, cable ties, tape, a dry and soft cloth 6. A multimeter 7. A case to store emergency supplies

※ It is recommended to replace the propellers only in an emergency situation during operations. After the emergency flight is over, please contact DJI technical support or an authorized agent for overhaul as soon as possible.

Checklist When Powered On

Type	Essentials
Remote Controller	<ol style="list-style-type: none"> 1. Confirm the control stick mode (Mode 1/2/3), and check in the control stick calibration page in the app if the proportion of the control lever is correct. 2. The remote controller has sufficient power and the battery is firmly installed. 3. Confirm that the channel used is automatic or custom, and then choose the operation frequency and channel according to the signal to noise ratio.
Battery	<ol style="list-style-type: none"> 1. All batteries, including Intelligent Flight Batteries and remote controller batteries, are fully charged. 2. The Intelligent Flight Batteries are firmly installed. 3. Check the battery level and voltage of each battery cell in the battery page in the app to make sure they are normal.
Flight Parameters Configuration	<ol style="list-style-type: none"> 1. The Failsafe action of the aircraft is what fits your mission needs. For example, the aircraft will land as a failsafe within in 50 m of the Home Point, and it will hover as a failsafe when it is within in 200 m from the Home Point. 2. The flight mode switch is set up correctly. 3. RTH altitude, height limits, distance limits, and obstacle sensing function are set up correctly.
Module Auto-Check	<ol style="list-style-type: none"> 1. View the module auto-check information on top of the screen in the app to check if there is any error prompt.
GNSS Positioning	<ol style="list-style-type: none"> 1. There are at least 7 satellites and the aircraft works in P-mode. 2. Enable RTK function, select the correct base station and channel, and make sure that RTK positioning is in use. Check in the RTK page if the heading and positioning are fixed.
Sensors	<ol style="list-style-type: none"> 1. Data on each IMU is shown in the app. IMU calibration can be performed successfully. 2. Data on each compass is shown in the app. The heading of the compass matches the physical one, and the needle is stable. 3. Compass calibration can be performed successfully. 4. The Vision System in all directions are enabled and there is no error prompt.
Top and Bottom Cooling Fans	<ol style="list-style-type: none"> 1. Touch the shell of the cooling fans or listen carefully to check if the cooling fans work normally without noise.
Firmware Consistency	<ol style="list-style-type: none"> 1. Connect the remote controller to the internet, then launch the app. Make sure that the app and the firmware versions of the aircraft, remote controller, payloads, and batteries match. Otherwise, the aircraft cannot take off or there may be risks. 2. Insert all Intelligent Flight Batteries into the aircraft to make sure that all of their firmware versions are up to date.

Motor Spin	<p>Link the remote controller and aircraft, make sure the FPV camera display in the app works normally, and then perform Combination Stick Command (CSC) to start the motors in a safe indoor area to make the motors spin at an idle speed. Then test the following. NOTE: Stay away from the spinning motors and propellers to avoid injuries during the test.</p> <ol style="list-style-type: none">1. The motors start without noise. There is no error prompt in the app.2. At the beginning when the motors start or the end when the motors stop, observe the motors to make sure that motors 1 and 3 rotate counter-clockwise while motors 2 and 4 rotate clockwise.
------------	---

Flight Test Checklist

Type	Essentials
Flight Test	<ol style="list-style-type: none"> 1. Make sure that there are no potential safety hazards or people within 5 m of the aircraft. 2. Make sure that the satellite count is more than 10 and there is sufficient light. Start video recording. 3. In P-mode, perform CSC to make the motors spin at an idle speed on the ground. Push the control sticks in each direction lightly to test. Then push the throttle stick down to the bottom until the motors stop. 4. In P-mode, perform CSC to make the motors spin at an idle speed on the ground. Observe to check if the aircraft shakes. Then push the throttle stick down to the bottom until the motors stop. 5. In P-mode, take off and then hover at a height of 5 m for 1 min. Check to see the aircraft horizontal drift is no more than 1 m and the height drift is no more than 0.5 m. Check the shake of the aircraft, battery status, sound of the motors and propellers. 6. Push the control sticks in each direction lightly to check if the aircraft responds correctly. 7. Gradually increase the movement of the control sticks to observe the attitude response and the shake of the aircraft when braking. 8. Set height limits and distance limits. Then test if the aircraft can obey the limits. 9. In P-mode, enable obstacle sensing. Then test if the aircraft can avoid obstacles in left, right, front, rear, and upward directions. 10. In P-mode, fly the aircraft more than 20 m away from the Home Point at an altitude less than the preset RTH altitude. Initial RTH using the RTH button on the remote controller to test if the aircraft can perform ascending, cruising, landing in order and the landing position has an error no more than 1 m from the Home Point. 11. Stop video recording after landing.
Checklist after Landing	<ol style="list-style-type: none"> 1. The propellers, motors, and aircraft body are intact, and there is no sign for collision or loose or broken structures. 2. The temperature of the motors is normal, no signs of uneven heating.

Regular Maintenance

It is recommended to perform inspection and maintenance regularly by following the items below to keep the aircraft in a good condition and reduce safety risks.

Maintenance Advice

Type	Maintenance Items	Maintenance Advice	Period
Basic Maintenance	<ol style="list-style-type: none"> 1. Regular maintenance items 2. Updates and calibration 3. Deep cleaning 	It is recommended to return to the factory or contact an authorized agent.	Total flight time is 150 hours, or the product has been used for 6 months.
Standard Maintenance	<ol style="list-style-type: none"> 1. Regular maintenance items 2. Updates and calibration 3. Deep cleaning 4. Components replacement due to wear and tear 	Factory service	Total flight time is 300 hours, or the product has been used for 12 months.
Premium Maintenance	<ol style="list-style-type: none"> 1. Regular maintenance items 2. Update and calibration 3. Deep cleaning 4. Component replacement due to wear and tear 5. Core component replacement 	Factory service	Total flight time is 900 hours, or the product has been used for 36 months.

Regular Maintenance Items

Propulsion System

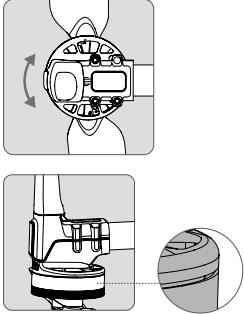
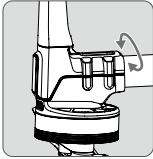
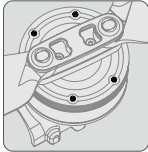
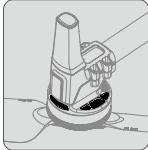
Type	Inspection Process and Solutions	Illustrations
<p>Motor Rotation</p>	<ol style="list-style-type: none"> 1. Unfold and secure the frame arms. 2. Rotate the rotor of the motor to check if there is any blockage or rubbing. Observe the gap between the rotor and stator of the motor to check if there is any rubbing with the motor base. 3. DO NOT fly the aircraft if there is any blockage or rubbing mentioned above. It is necessary to return to the factory for repair. 	
<p>Connection between Motor and Arm</p>	<ol style="list-style-type: none"> 1. Rotate the motor base around the central line of carbon tube to check if the motor and carbon tube connection is loose. 2. The four fixing screws are secure. 3. If any screw is loose, return to the factory for repair. 	
<p>Motor Upper Cover</p>	<ol style="list-style-type: none"> 1. The screws on the upper cover are not loose. There is no damage or crack on the upper cover. 2. If screws are loose, apply thread locker and tighten the screws. 3. If the upper cover is damaged or cracked, return to the factory for repair. 	
<p>Motor Air Filters</p>	<ol style="list-style-type: none"> 1. Air filters are not loose or damaged. 2. If they are loose or damaged, return to the factory for repair. 	

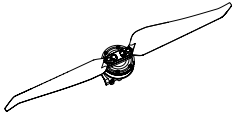
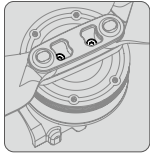

<p>Propellers</p>	<ol style="list-style-type: none"> 1. Check the propellers for visible deformation, severe wear, nicks, and cracks, and if there are any foreign materials. 2. Clean the propellers with a dry soft cloth. 3. Replace the propellers immediately if visible deformation, severe wear, nicks, or cracks occur. ※ 4. Replace the propellers after flying over 300 hours or using for one year. ※ 	
<p>Propeller Adapters</p>	<ol style="list-style-type: none"> 1. The propeller adapter screws are secure. 2. If the screws are loose, apply thread locker and tighten the screws. 3. The propeller adapters are not misshapen or broken. 4. Replace the propeller adapters if they are misshapen or damaged. 	

※ It is recommended to replace the propellers only in an emergency situation during operations. After the emergency flight is over, please contact DJI technical support or an authorized agent for overhaul as soon as possible.

Flight Controller

1. After the aircraft is powered on and self-check is complete, there are no error prompts in the app related to the flight controller.
2. In outdoor open environments, GPS signal has four bars within 1 min after powering on the aircraft, which indicates that the Home Point can be recorded automatically, and the RTK data meets the heading measurement standard.
3. In outdoor open environments, the interference of the compass after calibration is less than 50.
4. Sensor bias is less than 0.05 after IMU calibration.

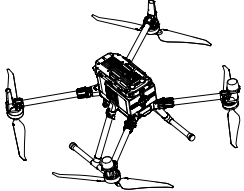
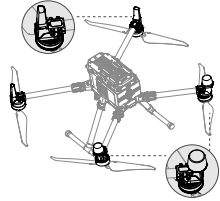
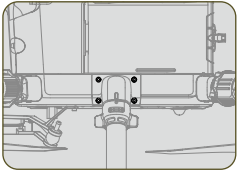
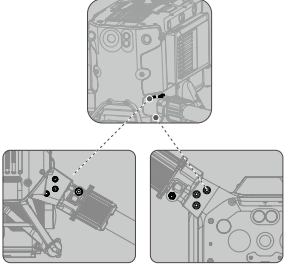
Aircraft Structure

Type	Inspection Process and Solutions	Illustrations
<p>Aircraft Appearance</p>	<ol style="list-style-type: none"> The aircraft body is clean and not damaged. Clean the aircraft body with a clean and soft cloth, especially for the lenses of the Infrared Sensing and Vision Systems and the heat dissipation vents. 	
<p>Screws</p>	<ol style="list-style-type: none"> All the screws on the aircraft body are tightened, especially the screws connecting the motor and the carbon tube. 	
<p>Landing Gear Base</p>	<ol style="list-style-type: none"> Screws are secure. There is no damage or cracks. 	
<p>Frame Arms</p>	<ol style="list-style-type: none"> The 28 screws on the four frame arms are secure. The arm junctions are not damaged or cracked. Grab the carbon tube and shake the arm slightly to check if there is no obvious shake. 	
<p>Frame Arm LEDs</p>	<ol style="list-style-type: none"> There is no foreign object or damage on the surface. 	

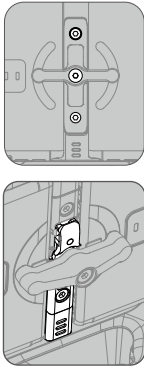
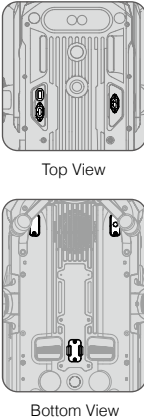
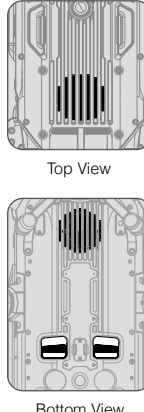
<p>Battery Compartment</p>	<ol style="list-style-type: none"> 1. The three screws on the battery lock and its mounting base are secure. 2. The battery ports are clean and dry without any corrosion. Clean out any water and dust if there is any. 3. The eject mechanism under the battery locker can be ejected smoothly without shaking when the batteries are locked. 	
<p>Data Ports</p>	<ol style="list-style-type: none"> 1. Clean the foreign objects near the ports with a gauze. 2. If the port is in use, disconnect the cable, then check if there are foreign objects in the port with the help of a light. 3. Remove the foreign objects such as small pieces of stones and pieces of paper in the port using tweezers. 4. Clean the gluey foreign materials in the port with a gauze. 5. Place the aircraft so that the port is facing downward, and then use a tool such as a gauze or brush to remove the powder materials in the port. Note to sweep from the inside to the outside. 	 <p>Top View</p> <p>Bottom View</p>
<p>Heat Dissipation Vents</p>	<ol style="list-style-type: none"> 1. There is no blockage in the heat dissipation vents. The cooling fans work smoothly without noise. 	 <p>Top View</p> <p>Bottom View</p>

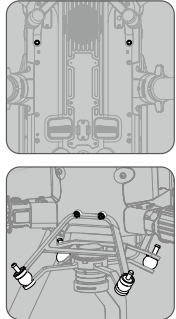
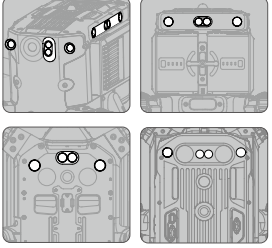
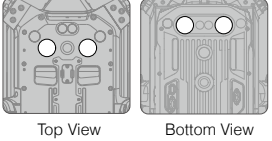
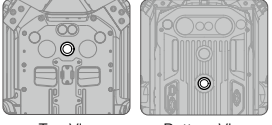
<p>Rubber Port Covers</p>	<p>1. The rubber port covers are not damaged or loose.</p>	
<p>Gimbal Damping Plate</p>	<p>1. The dampeners are not damaged, loose, or aged. The gimbal connector can rotate smoothly.</p> <p>2. The screws connecting the damping plate and aircraft body are secure.</p>	
<p>Infrared Sensing and Vision System Lenses, Auxiliary Lights, and Beacons</p>	<p>1. Clean the lenses with a soft cloth.</p> <p>2. Lenses are not loose and have no cracks.</p> <p>3. The auxiliary lights and beacons are not loose and cracked.</p>	<p>Infrared Sensing and Vision Systems</p>  <p>Auxiliary Lights</p>  <p>Top View Bottom View</p> <p>Beacons</p>  <p>Top View Bottom View</p>

TB65 Battery

Battery Maintenance Conditions

Maintenance is required when any of the events below occur.

1. Every 100 cycles.
2. The battery is idle for more than six months.
3. There is a maintenance prompt in the app.

Checklist for Maintenance

1. Charge and discharge the battery as per instructions.
2. Make sure the cell voltage difference is less than 0.1 V after the battery is fully charged and left stationary for two hours.
3. Make sure the battery is not swollen, leaky, or damaged.
4. Make sure battery terminals are clean.
5. Make sure the battery firmware is updated to the latest version.

Standard Charge and Discharge Operation Instructions

1. Charge the battery to 100% and leave the battery stationary for more than 24 hours.
2. Install the battery into the aircraft before flight. If the remaining power level is less than 20%, land the aircraft and remove the battery.
3. Leave the battery stationary for more than six hours.
4. Charge the battery to 100% power level.
5. Repeat the above steps.

Battery Replacement Standard

1. The battery is visibly swollen, leaky, or damaged.
2. There is a prompt of battery cell damage or over discharge in the app.
3. The battery is rated for 400 cycles. The stability of the battery will be affected after the rated cycles. In this case, make sure to replace the battery. Otherwise, users are responsible for the device damage and third-party losses caused by batteries exceeding the rated cycles.
4. The battery error still exists after performing the standard charge and discharge operations twice continuously.

Battery Disposal

1. Fully fill in an insulated bucket with 5% salt solution. Put the battery into it for more than 48 hours to fully discharge the battery.
2. It is recommended to recycle the battery by a recycling agent to avoid environmental pollution.

Emergencies

1. Put out any battery fire using sand or a dry powder fire extinguisher.
2. Put the battery into 5% salt solution immediately if the battery shell has visible damage. DO NOT use the battery afterward.
3. If any electrolytes make contact with your skin, immediately wash the affected area

with clean running water or alkaline hand sanitizer for at least 15 minutes. See a doctor immediately.

Warnings

1. It is recommended to charge and discharge the battery in a special explosion-proof cabinet.
2. DO NOT charge the battery near flammable materials, objects or on flammable surfaces.
3. DO NOT use the battery in a humid environment to avoid short circuit.
4. Never disassemble or pierce the battery in any way.
5. Store Intelligent Flight Batteries in a well-ventilated and dry place.
6. Initial RTH immediately when the battery temperature is 80° C (176° F) or higher.

Vision System Calibration

Vision System calibration is required when any of the events below occurs.

1. The total flight time is 200 hours.
2. There is a calibration prompt in the app.

Health Management System

Users can view the status of each module and upload the log with abnormal status in the Health Management System (HMS) page in the DJI Pilot 2 app.

1. Enter the HMS page in DJI Pilot 2.

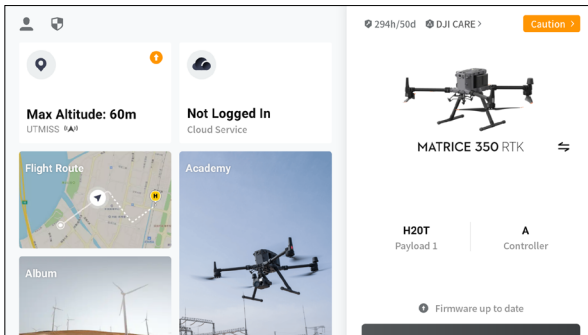

2. The health condition of each module of the connected device will be displayed onscreen.

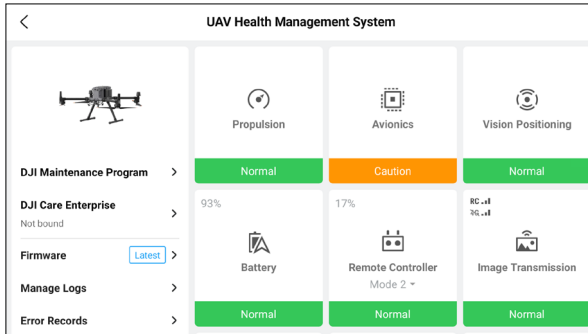

3. If any module is abnormal, tap to view the warning message.

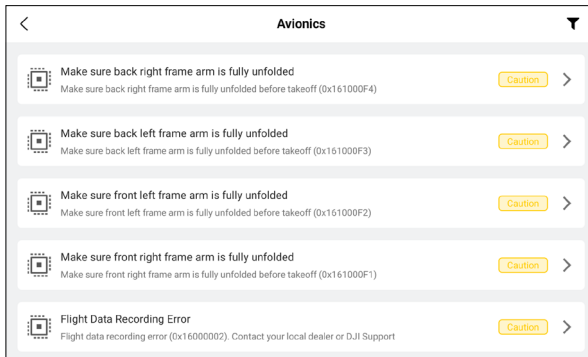

4. Tap the warning message to view the help document for troubleshooting. If the abnormal status still exists after check by following the document, users can upload the log and contact DJI Support for help.

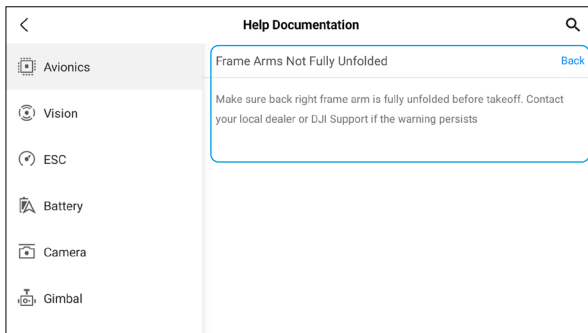

- View the error records and check if there are frequent error prompts or critical warnings. If the problem cannot be solved, contact DJI Support.

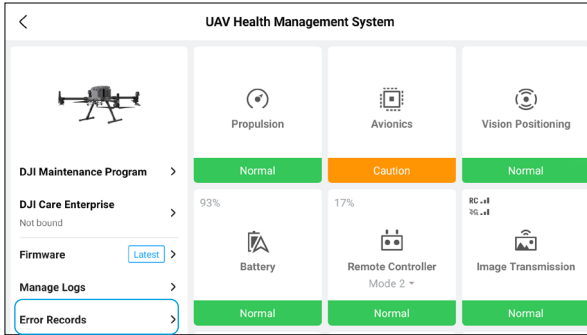

Firmware Update

Make sure that firmware of the product and its relevant products are all up to date.

After-Sales Service

Warranty Policy

Please visit <https://www.dji.com/en/service/policy> to check the product warranty period and warranty policy.

Repair Channel

Please visit <https://repair.dji.com/repair/index> and submit an Online Repair Request following the instructions.

Appendix

Maintenance Record

Maintenance Record Table		
Maintenance Date		Maintenance Items
Total Flight Time	(hours)	
Maintainer Signature		<input type="checkbox"/> Propulsion System <input type="checkbox"/> HMS <input type="checkbox"/> Flight Controller <input type="checkbox"/> Vision System Calibration <input type="checkbox"/> Aircraft Body Structure <input type="checkbox"/> Firmware Update <input type="checkbox"/> Batteries <input type="checkbox"/> Core Components Replacement <input type="checkbox"/> Component Replacement Due To Wear and Tear
Maintenance Date		Maintenance Items
Total Flight Time	(hours)	
Maintainer Signature		<input type="checkbox"/> Propulsion System <input type="checkbox"/> HMS <input type="checkbox"/> Flight Controller <input type="checkbox"/> Vision System Calibration <input type="checkbox"/> Aircraft Body Structure <input type="checkbox"/> Firmware Update <input type="checkbox"/> Batteries <input type="checkbox"/> Core Components Replacement <input type="checkbox"/> Component Replacement Due To Wear and Tear
Maintenance Date		Maintenance Items
Total Flight Time	(hours)	
Maintainer Signature		<input type="checkbox"/> Propulsion System <input type="checkbox"/> HMS <input type="checkbox"/> Flight Controller <input type="checkbox"/> Vision System Calibration <input type="checkbox"/> Aircraft Body Structure <input type="checkbox"/> Firmware Update <input type="checkbox"/> Batteries <input type="checkbox"/> Core Components Replacement <input type="checkbox"/> Component Replacement Due To Wear and Tear

Maintenance Record Table

Maintenance Date		Maintenance Items
Total Flight Time	(hours)	<input type="checkbox"/> Propulsion System <input type="checkbox"/> HMS <input type="checkbox"/> Flight Controller <input type="checkbox"/> Vision System Calibration
Maintainer Signature		<input type="checkbox"/> Aircraft Body Structure <input type="checkbox"/> Firmware Update <input type="checkbox"/> Batteries <input type="checkbox"/> Core Components Replacement <input type="checkbox"/> Component Replacement Due To Wear and Tear
Maintenance Date		Maintenance Items
Total Flight Time	(hours)	<input type="checkbox"/> Propulsion System <input type="checkbox"/> HMS <input type="checkbox"/> Flight Controller <input type="checkbox"/> Vision System Calibration
Maintainer Signature		<input type="checkbox"/> Aircraft Body Structure <input type="checkbox"/> Firmware Update <input type="checkbox"/> Batteries <input type="checkbox"/> Core Components Replacement <input type="checkbox"/> Component Replacement Due To Wear and Tear
Maintenance Date		Maintenance Items
Total Flight Time	(hours)	<input type="checkbox"/> Propulsion System <input type="checkbox"/> HMS <input type="checkbox"/> Flight Controller <input type="checkbox"/> Vision System Calibration
Maintainer Signature		<input type="checkbox"/> Aircraft Body Structure <input type="checkbox"/> Firmware Update <input type="checkbox"/> Batteries <input type="checkbox"/> Core Components Replacement <input type="checkbox"/> Component Replacement Due To Wear and Tear

DJI Support

<http://www.dji.com/support>

This content is subject to change without prior notice.

Download the latest version from



<https://enterprise.dji.com/matrice-350-rtk/downloads>

Copyright © 2024 DJI All Rights Reserved.