

MD950TW-RS485 General Specification.

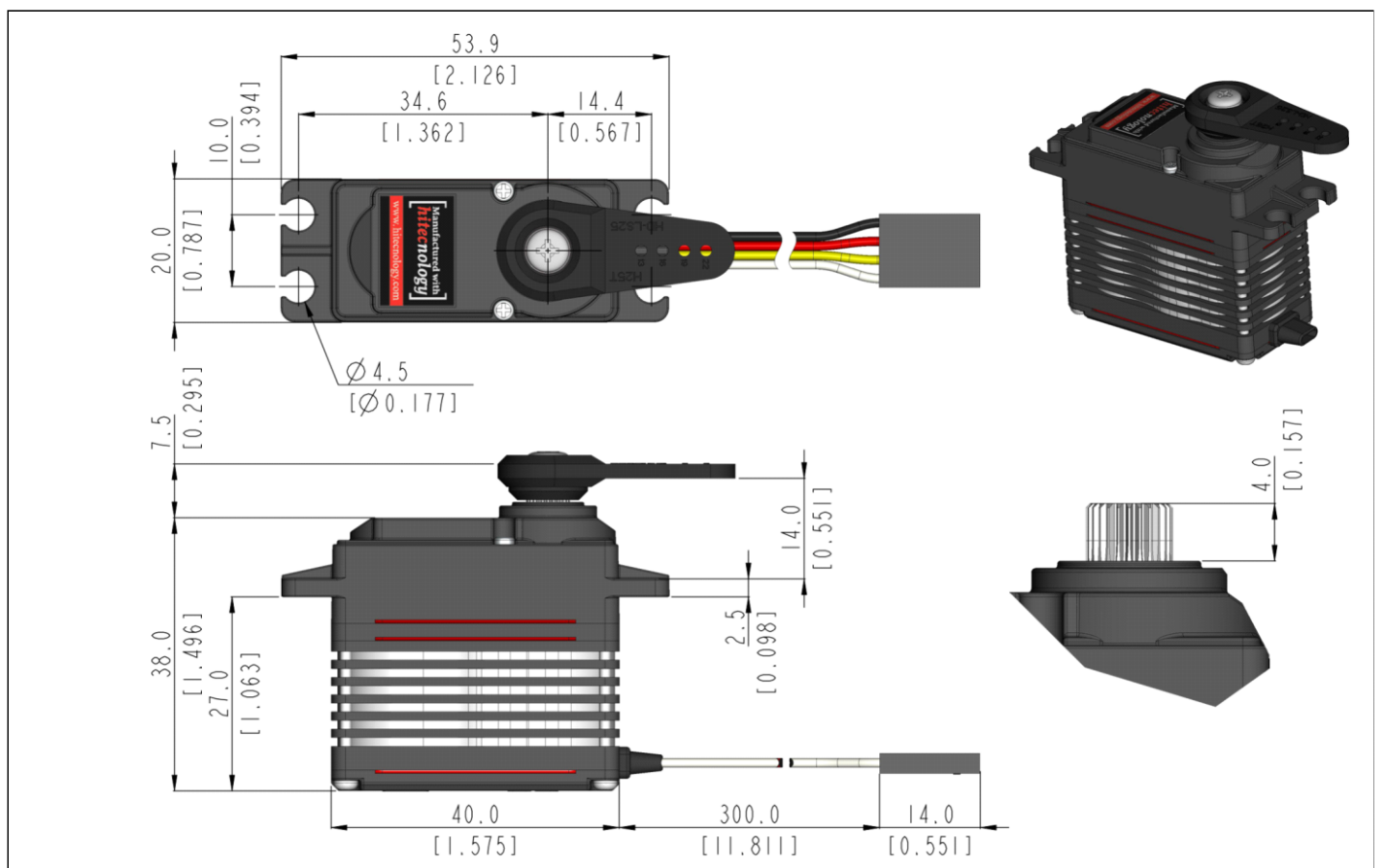

Control System	RS-485			-
Position Sensor Type	Contactless Magnetic Encoder			-
Motor Type	Coreless			At the Max voltage, it is recommended to be used only for a short time duration.
Operating Voltage Range	4.0 ~ 8.4V			
Voltage	4.8V	6.0V	7.4V	At 25°C(±10%), 45%RH(±10%) <u>measurement environment</u>
No Load Speed	0.23sec/60°	0.17sec/60°	0.14sec/60°	
Stall Torque	21.0kgf-cm (291.64oz-in)	29.0kgf-cm (402.73oz-in)	35.0kgf-cm (486.06oz-in)	
Peak Efficiency Torque	4.2kgf-cm (58.33oz-in)	5.8kgf-cm (80.55oz-in)	7.0kgf-cm (97.21oz-in)	
Standing Current	30mA	30mA	30mA	
No Load Running Current	300mA	390mA	500mA	
Stall Current	3,700mA	4,800mA	6,200mA	
Deadband	n/a	n/a	n/a	
Operating Travel	Default: ±60°, Programmable: Max 160°			-
Continuous Rotation	n/a			-
Operating Temperature Range	-20°C ~ +60°C (-4°F ~ +140°F)			-
Storage Temperature Range	-30°C ~ +80°C (-22°F ~ +176°F)			-
Connector Wire Length	300mm (11.81inch)			
Connector Wire Gauge	20AWG			
Dimensions	40.0mm x 20.0mm x 38.0mm (1.575inch x 0.787inch x 1.496inch)			General Tolerance ±0.1mm
Weight	68.0g (2.399oz)			Excluding the weight of Horn
Bearing Type	2 Ball Bearing			-
Case Material	Engineering plastic & Aluminum Heat Sink			-
Gear Material	1 Metal-Plastic & 3 Titanium Alloy Gears			-
Gear Train Backlash	Max 0.5°			-
Horn Gear Spline	25T(Ø6)			-
IP-Rating	IP55			-
Servo Amplifier Type	32bit programmable Digital			-



1:1 scale (Unit : mm[inch])

- This product should not be used directly on the human body for medical purposes.
- This product should not be used for war weapons.
- All specifications are subject to change without notice.
- Be careful as strong magnetic fields may cause malfunction of the product.

