

DJI O3 AIR UNIT

User Manual

v1.0 2023.03

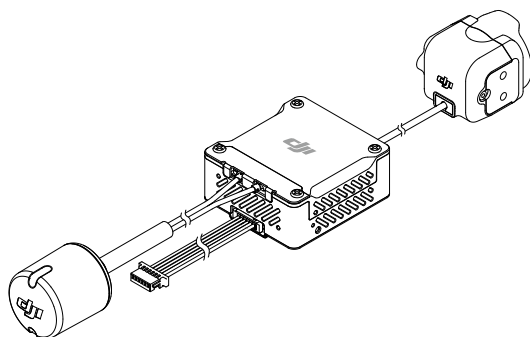

Searching for Keywords

Search for keywords such as “battery” and “install” to find a topic. If you are using Adobe Acrobat Reader to read this document, press Ctrl+F on Windows or Command+F on Mac to begin a search.

Navigating to a Topic

View a complete list of topics in the table of contents. Click on a topic to navigate to that section.

Printing this Document

This document supports high resolution printing.

Contents

Using This Manual	2
Legend	2
Read Before First Use	2
Video Tutorials	2
Download DJI ASSISTANT™ 2 (Consumer Drones Series)	2
Warning	3
DJI O3 Air Unit	4
Diagram	4
Installation and Connection	4
Activation	8
Firmware Update	8
Linking	8
Operating Channel	9
Video Recording	10
Goggles Home Screen and Menu	11
Home Screen	11
Menu	12
Canvas Mode	13
Maintenance	14
Parts Replacement	14
After-Sales Information	15
Supported DJI Goggles and Remote Controller	16
DJI Goggles 2	16
DJI FPV Goggles V2	22
DJI FPV Remote Controller 2	26
Appendix	29
Specifications	29

Using This Manual

Legend

 Important

 Hints and tips

 Reference

Read Before First Use

Watch all the tutorial videos on the DJI™ official website and read the in-box product documents first, then read this user manual carefully to ensure correct and safe usage of this product.

Contact DJI or a DJI authorized dealer if you have any questions or issues during installation and use of this product.

Video Tutorials



<https://www.dji.com/o3-air-unit/video>

Download DJI ASSISTANT™ 2 (Consumer Drones Series)



<https://www.dji.com/o3-air-unit/downloads>

Warning

- ⚠ • The air unit may become hot during or after operation. DO NOT touch the air unit before it cools down.
 - DO NOT use the air unit for an extended period in high-temperature environments with poor ventilation. This may lead to overheating and loss of image transmission.
 - Mount the air unit on the aircraft with good ventilation and heat dissipation. DO NOT install the air unit in an enclosed area. Otherwise, the air unit will overheat during use and the image transmission may be lost.
 - When the air unit is powered on, it automatically enters the low-power state to avoid overheating, which negatively affects image transmission performance. Once the aircraft takes off or the recording starts, the air unit automatically exits the low-power state and resumes normal image transmission performance. Make sure to take off as soon as possible or the air unit is well ventilated.
 - Make sure that the external power supply for the air unit is a lithium battery (2S-6S) with an input power between 7.4-26.4 V. Otherwise, the air unit may work abnormally or be damaged.
 - DO NOT connect the power cable with the power GND cable directly or plug or unplug the cables after the air unit is powered on. Otherwise, the equipment may be damaged.
 - DO NOT obstruct or twist the antenna of the air unit. Otherwise, the transmission may be affected or blocked.
 - Follow the instructions in the quick start guide or user manual when installing the air unit. Incorrect installation may cause abnormal performance or even damage to the air unit.
 - Keep all electronic devices as far away from each other as possible during installation to minimize electromagnetic interference.
 - Make sure that all connections are secure and all parts are working properly.
 - Make sure that there are no other transmitting devices in the surrounding area that may cause interference. DO NOT use the same frequency band as other devices. Otherwise, the transmission performance will be affected.
 - Make sure that there are no other transmitting devices in the surrounding area that may cause interference. DO NOT use the same frequency band as other devices. Otherwise, the transmission performance will be affected.
 - Make sure you fully understand and abide by local laws and regulations before using this product.
 - This product is not intended for children.
-

DJI O3 Air Unit

DJI O3 Air Unit is an advanced video transmission device featuring DJI long-range low-latency HD transmission O3+ technology. The air unit can be mounted on a racing drone and used with DJI goggles and a remote controller to transmit video, control signals, and flight controller information wirelessly.

Diagram

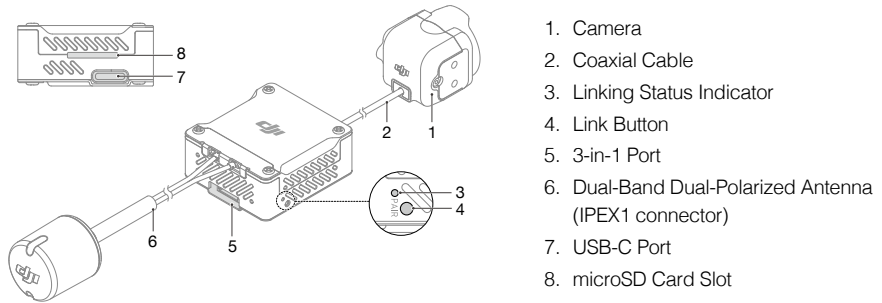

Installation and Connection

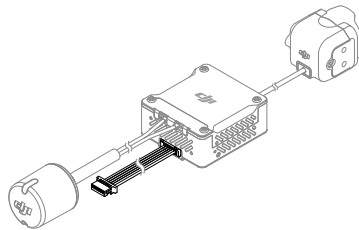

Mount the air unit on a racing drone or other devices.

- ⚠ Mount the air unit on the aircraft with good ventilation and heat dissipation. DO NOT install the air unit in an enclosed area. Otherwise, the air unit will overheat during use and the image transmission may be lost.

Use glue or screws to install the transmission module. If using screws for installation, remove the four M1.6 x L6 mm screws on either side of the module. Install the module on a racing drone or other device with the screws.

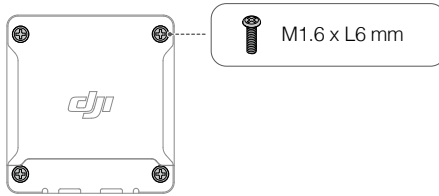

There are four M2 x L4 mm screws attached to both sides of the camera module (the depth of the screw hole is 2 mm). Remove the screws and use them to mount the camera to the aircraft frame if the thickness of the aircraft frame is between 2-3 mm. Adjust the camera to an appropriate angle based on your requirements when installing.

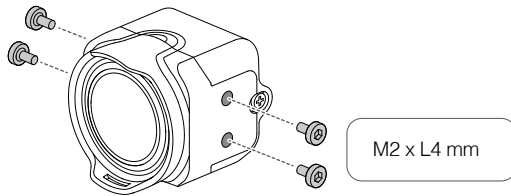

- ⚠ • Choose the screw length carefully when installing the camera module. The length of the screw should not exceed the sum of the screw hole depth (2 mm) and the thickness of the aircraft frame. If the screw is too short, the camera module may not be securely fastened. If the screw is too long, it may cause damage to the internal structure.
- To obtain the optimal transmission, keep the antenna away from any metal or carbon fiber structures, and make sure that the antenna is not blocked by any frame structures.

3-in-1 Cable

Connect the 3-in-1 cable to the 3-in-1 port on the air unit. Refer to the diagram below to solder the other end of the cable to the flight controller. An electric soldering iron and soldering tin are required for connection. Make sure that there are no short circuits or open circuits when soldering the cables.

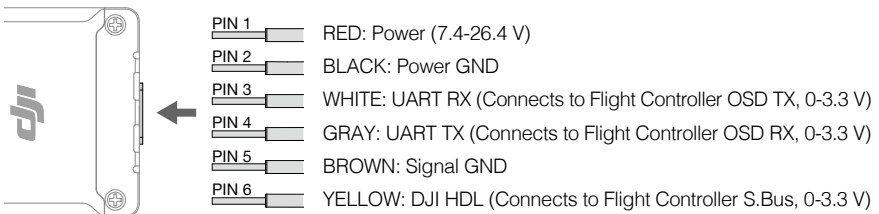

Important Notice and Installation Guidelines

❖ DJI O3 Air Unit Installation Method and Cooling Effect

DJI O3 Air Unit is integrated with both the image transmission module and the camera module. Compared with the last generation DJI Digital FPV System, the size of DJI O3 Air Unit is reduced by 40%, while the power consumption is increased by 40%. Restricted by its cooling condition, extra ventilation and heat dissipation measures are necessary when installing the air unit.

Standby Time (from cold start):

- Environment temperature 25° C (77° F): 8 mins
- Environment temperature 35° C (95° F): 5 mins

When installing the DJI O3 Air Unit, make sure that the RX and TX pins are correctly connected to the flight control board. The air unit can apply different temperature control strategies for the standby and flight states.^[1]

[1] DJI O3 Air Unit has two sets of temperature control strategies for the standby state and the flight state:

- In the standby state, the protection system will be activated to automatically shut down the air unit after overheating.
- In the flight state, there will be a prompt alert after overheating and the video recording will end. At this time, the video transmission will remain connected and the aircraft must return and land within 30 seconds. If the temperature of the internal IC board continues to rise, the protection system will be activated to shut down the air unit automatically.

Installation Guidelines

Recommended installation practices that are effective for ventilation and heat dissipation:

- It is recommended to mount the air unit in a position close to the propellers (distance between the air unit module and the propellers within 10 mm) so that the downwash can be effectively utilized.
- Use a heat conductive material to connect the aircraft frame and the air unit module. This will dissipate heat to the carbon plate and other metal components of the frame. Conducting the heat will extend the operating time.
- DO NOT install the air unit in an enclosed area.



The metal casing of the DJI O3 Air Unit will become hot after being powered on. The air unit should not be installed in a position that is easily accessible.

❖ Video Image Shakes After Enabling RockSteady

Mechanical vibration at certain frequencies may result in abnormal EIS (electronic image stabilization) performance of the DJI™ O3 Air Unit.

Cause

IMU Resonance

- The usual ESC (electronic speed control) PWM (pulse-width modulation) control frequency is 24 kHz by default, and the camera IMU frequency is around 24 to 30 kHz. If there is no effective vibration absorbing measure, the motor vibration may be transmitted to the camera IMU, causing resonance because the frequencies coincide. The resonance will affect the IMU data accuracy and EIS performance of the video stabilization application.^[2] As a result, the processed video image shakes, but the liveview image is not affected.
- Usually, aircraft frames with TPU or vibration absorbing rubber are not prone to the IMU resonance issue.

[2] Video stabilization application: refers to either the DJI O3 Air Unit EIS function or a third-party video stabilization software.

Rolling Shutter Effect

If the rolling shutter effect appears in both the liveview and the video image, it is usually because the propeller vibration (frequency is around a few hundred Hz) is transmitted to the camera through the aircraft frame.

Troubleshooting and Tuning Guide

Follow the steps below to troubleshoot and fix the image stabilization issue:

Step 1: rule out the IMU resonance issue

1. Remove the propellers from the aircraft. Make sure that the camera is securely mounted and the aircraft is placed stationary on the ground. Then enable RockSteady and start recording.
2. Start the motors and slowly push the throttle to the full position. Observe the liveview in the goggles. If the liveview is not shaking, stop the motors and end the recording. Otherwise, check the camera and make sure it is securely mounted.
3. Check the recorded video. If the video image shakes, the issue is most likely caused by the resonance between the frame and the camera IMU. In this case, refer to the following solutions:

Solutions

- a. Change the ESC PWM control frequency to 48 kHz or 96 kHz and test again.
- b. If the video image shakes after the solution (a) is adopted, apply a softer vibration absorbing structure between the camera and the aircraft frame. Repeat the above testing procedures until the video image does not shake.

Step 2: rule out the rolling shutter effect issue

After ruling out the IMU resonance issue, check if the video image has the rolling shutter effect.

1. Install the propellers on the aircraft and make sure that the propellers are not damaged.
2. Fly the aircraft and start recording with RockSteady enabled. Check the video image after the flight. If the video image has a rolling shutter effect, try the following solutions:
 - a. Adjust the vibration absorbing structure between the camera and the aircraft frame again.
 - b. Adjust the tightness of the screws that fasten the camera to the aircraft frame.

If the issue still exists after all the above methods are completed, **contact DJI for support**.

Activation

Connect the air unit to a computer using the USB-C port, and run DJI Assistant 2 (Consumer Drones Series) for activation.

- ⚠ Make sure to activate the device before using for the first time. Otherwise, some functions will be unavailable:
 - If the air unit is not activated, its transmission power will be limited (≤ 25 mW), and the menu screen of the connected goggles cannot be operated.
 - If the goggles are not activated, only linking is available and the menu screen cannot be operated. Additionally, the device will also be set in the public channel and cannot be set to other channels after linking. Note that the public channel is easily prone to interference from other transmission devices.

Firmware Update

Use DJI Assistant 2 (Consumer Drones Series) to update the air unit, the goggles, and the remote controller separately.

1. Power on the device and connect it to a computer with a USB-C cable.
2. Launch DJI Assistant 2 and log in with a registered DJI account.
3. Select the device and click "Firmware Update" on the left side of the screen.
4. Select the firmware version.
5. DJI Assistant 2 will download and update the firmware automatically.
6. Restart each device after the firmware updates are complete.

- ⚠ Make sure that the device has sufficient power before updating firmware.

Linking

Make sure that all devices have been updated to the latest firmware versions before linking.

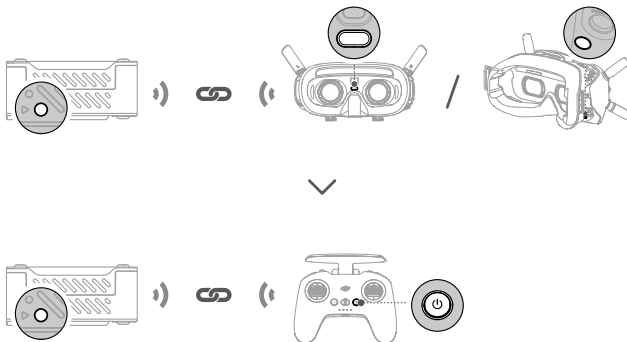

The air unit must be linked to the goggles before the remote controller.

1. Power on the air unit, the goggles, and the remote controller.
2. Press the link button of the air unit and the goggles respectively. The linking status indicator of the air unit blinks red and the goggles start to beep continually.
3. Make sure the distance between the air unit and the goggles is within 0.5 m. Once linking is successful, the linking status indicator of the air unit turns solid green. The goggles stop beeping and the live view will be displayed.
4. Press the link button of the air unit and the linking status indicator of the air unit blinks red. Press and hold the power button of the remote controller. The remote controller starts to beep continually and the battery level LEDs blink in sequence.
5. Make sure the distance between the air unit and the remote controller is within 0.5 m. Once linking is successful, the linking status indicator of the air unit turns solid green and the remote controller stops beeping.

Operating Channel

This product supports two channel modes: manual and auto. The channel mode can be set in the goggles menu as follows:

Open the goggles menu, select Transmission > Channel Mode, and then select Auto or Manual according to the actual situation.

In auto mode, the channel with the strongest signal (between 5.725 GHz and 5.850 GHz) will be automatically selected.

In manual mode, the channel can be manually selected from the following bandwidths:

Bandwidth	Channel and the Corresponding Central Frequency
40 MHz	Channel 1: 5794.5 MHz
20 MHz	Channel 1: 5768.5 MHz
	Channel 2: 5804.5 MHz
	Channel 3: 5839.5 MHz
10 MHz	Channel 1: 5768.5 MHz
	Channel 2: 5804.5 MHz
	Channel 3: 5839.5 MHz



- Make sure you fully understand and abide by local laws and regulations before using this product.
- Some channels may not be available in some countries due to local legal restrictions.

Power on and connect the air unit to a computer and run DJI Assistant 2. The air unit will update to the radio mode of the current region automatically. When the goggles or remote controller are connected to the air unit, the region of their radio modes will also update automatically.

Video Recording

Make sure the air unit, the goggles, and the remote controller are connected with the racing drone and both the air unit and goggles have microSD cards inserted. If you have enabled Auto Record on Takeoff in the goggles menu, the air unit and the goggles will start video recording automatically after takeoff, and will stop recording when the motors stop.

The recording will automatically stop when the following occurs.

Air Unit:

1. The microSD card is full or an error occurs during recording;
2. The air unit enters low-power mode because its temperature is too high.

Goggles

1. The microSD card is full or an error occurs during recording;
2. The air unit enters low-power mode because its temperature is too high;
3. The transmission signal is lost, or exits live view;
4. The live view source is changed, such as switching between Player to Audience mode.

Powering off the device or removing the microSD card during recording will result in a corrupted video file, which cannot be played. Insert the microSD card into the device again, and the device will attempt to recover the corrupted video file automatically after power-on.

Goggles Home Screen and Menu

 The actual screen interface and menu options may differ from the descriptions in this manual and vary depending on the goggles used.

Home Screen

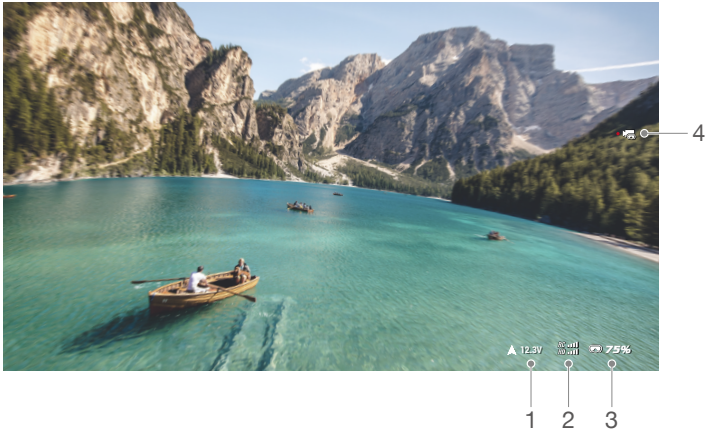

1. Aircraft Voltage

Displays the battery voltage of the aircraft battery read by the flight controller.

2. Remote Controller and Video Downlink Signal Strength

Displays the remote controller signal strength between the aircraft and remote controller and the video downlink signal strength between the aircraft and the goggles.

3. Goggles Battery Level

4. Camera

Displays the shooting mode and the recording time remaining.

Menu

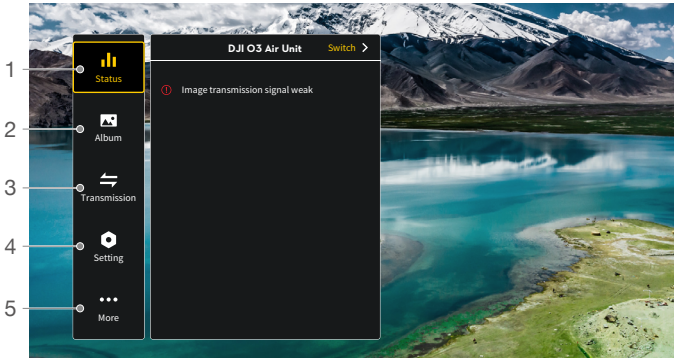

1. Status

Displays the information of prompts or alerts.

Use the switch function to change the aircraft used (only available on DJI Goggles 2).

2. Album

Manage or view the photos or videos stored on the microSD card.

3. Transmission

The transmission menu includes the following settings:

- Enable or disable the broadcast mode. When the broadcast mode is enabled, other devices can find the goggles and enter the channel to see the camera view.
- Set the focus mode to on, off, or auto.
- Set the channel mode to auto or manual. In manual mode, users can select a channel manually from 10 MHz, 20 MHz, and 40 MHz bandwidth.
- If any nearby video transmission device turns on the broadcast mode, the device can be found in the audience mode. The user can select a device to see the camera view of that device.

4. Settings

- Control (only available for DJI remote controller): Set the stick mode and calibrate the remote controller.
- Camera: Set shooting related functions and parameters, or format the microSD card.



Note that the data cannot be recovered after formatting. Operate with caution.

- Display: Adjust screen brightness and zoom.
- About: View device information, such as the serial number and the firmware of the goggles and linked air unit. Set the system language. Reset the goggles and the linked air unit to the default settings.

5. More (only available on DJI Goggles 2)

The screen casting function enables you to cast the video playing on the mobile device to the goggles screen (the video player must support the screen casting function).

Canvas Mode

Canvas Mode enables the flight controller to display OSD elements (such as battery voltage and flight distance) on the screen of the goggles. Users can configure which OSD elements to display and where to display the OSD elements on the screen using the Betaflight Configurator software.

Canvas Mode is compatible with Betaflight 4.3.0 and later. Canvas Mode is set differently depending on the betaflight firmware version.

1. Hardware Connection: connect the UART RX of the air unit to one of the UART TX serial ports (take UART4 as an example) of the flight control board.
2. Configuring UART: open the Betaflight Configurator software and select Ports. Turn on the MSP switch for the corresponding UART TX serial port (UART4) and set baud rate to 115200. Click Save and Reboot.

 If Betaflight 4.4.0 or later is used, set Peripherals to MSP+Displayport.

3. Configuring CLI:

Select CLI from the Betaflight Configurator software and make the following configuration:

- 1) Set the `osd_displayport_device` to MSP:

```
set osd_displayport_device = MSP
```

- 2) Specify the MSP serial port number. The number here should be the MSP UART TX serial port number minus 1. In this example, it should be 3.

```
set displayport_msp_serial = 3
```

 If Betaflight 4.4.0 or later is used, the MSP serial port number does not need to be specified.

- 3) Save and exit:

```
save
```

Canvas Mode initial setup is complete.

Maintenance

Parts Replacement

⚠ Be careful not to damage the parts or connectors when replacing.

Camera Module (Coaxial Cable Included)

🔧 After replacing the camera, use an external power supply to power on the air unit. Connect the air unit to a computer and launch DJI Assistant 2 to update the camera calibration file.

1. Loosen the two screws that secure the cover of the coaxial cable connector, then remove the cover.

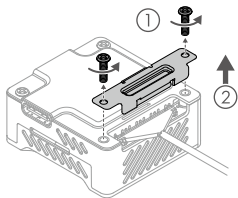

2. Use an appropriate tool (tweezers) to disconnect the cable from the air unit and then remove the camera module with the coaxial cable.

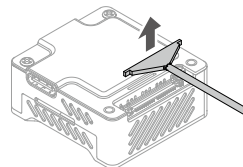

3. Prepare the new camera module (with the coaxial cable) and connect the coaxial cable to the air unit. Make sure the cable is connected firmly.

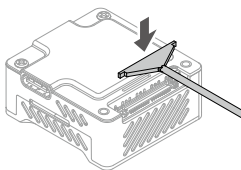

4. Reinstall the cover and tighten the screws.

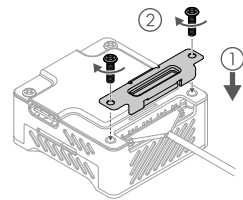

Antenna

1. Loosen the two screws that secure the cover of the antenna connector, then remove the cover.

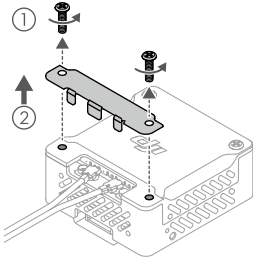

2. Use an appropriate tool (tweezers) to disconnect and lift the plugs, and then remove the antenna.

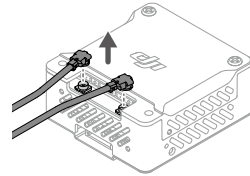

3. Prepare the new antenna. Align the plugs with the antenna connectors on the air unit, press the plugs down to make sure they are securely connected.

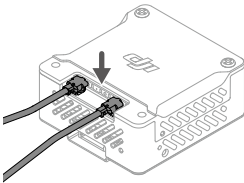

4. Install the cover back and tighten the screws.

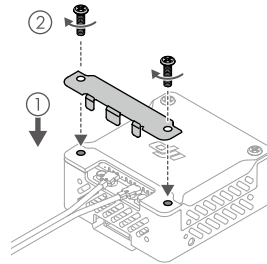

After-Sales Information

Visit <https://www.dji.com/support> to learn more about after-sales service policies, repair services, and support.

Supported DJI Goggles and Remote Controller

DJI O3 Air Unit supports the following DJI goggles and remote controller:

- Goggles:
 - DJI Goggles 2
 - DJI FPV Goggles V2
- DJI FPV Remote Controller 2

DJI Goggles 2

Diagram

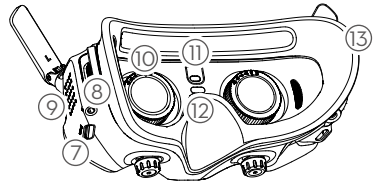
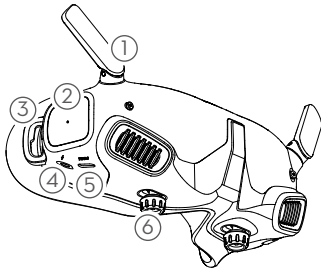



1. Antennas
2. Touch Panel
3. Headband Attachment
4. Power Port
5. USB-C Port
6. IPD (Interpupillary Distance) Slider / Diopter Adjustment Knob (hereinafter referred to as "knob")

7. microSD Card Slot
8. 3.5 mm Audio Port
9. LED Dot Matrix Display
10. Lens
11. Proximity Sensor
12. Link Button
13. Foam Padding

Installation and Wearing

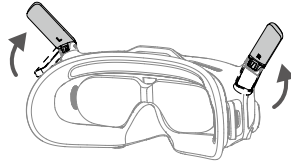
1. Unfold the antennas.



 Fold the antennas to avoid damage when the goggles are not in use

2. Remove the screen protector.

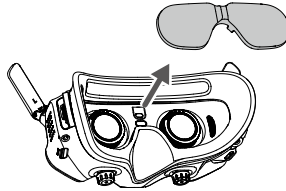

 Re-attach the screen protector after use to protect the lens and prevent damage caused by direct sunlight.

3. Attach the headband to the goggles.

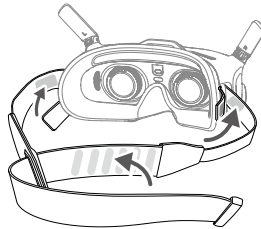

4. After the devices are powered on and the image transmission is displayed, wear the goggles and adjust the headband until the goggles fit comfortably.

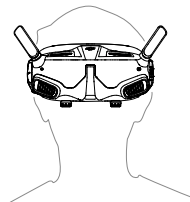

5. Rotate both the knobs in the direction as shown to unlock them. Once unlocked, the knobs will pop out.

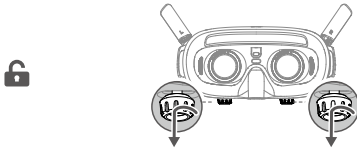

6. Toggle the knobs left and right to adjust the distance between the lenses until the images are properly aligned.

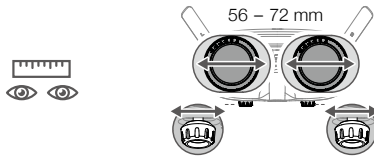

7. Slowly rotate the knobs to adjust the diopter. The supported adjustment range is from -8.0 D to +2.0 D.

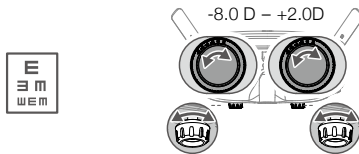

- ⚠️
- The diopter lenses do not support astigmatism correction. If you require astigmatism correction or if the goggles' diopter is unsuitable, you can purchase additional lenses and use the eyeglass frames provided to install them on the goggles. If the installed lens supports astigmatism correction, do not rotate the knob after the eyeglass frame is installed. Otherwise, the astigmatism axis will shift resulting in blurred vision. Make sure to adjust the diopter of the goggles before installing the eyeglass frames.
 - When adjusting the diopter for the first time, you are advised to adjust to a degree that is slightly lower than the strength of your actual eyeglasses. Give your eyes enough time to adapt, then adjust the diopter again until you get a clear view. Do not use a diopter higher than your actual eyeglass power to avoid eyestrain.

8. After you get a clear view, press the knobs in and rotate them in the direction as shown to lock in the lenses' position and the diopter.

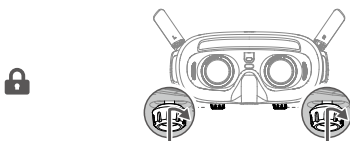

Power Supply

Use the power cable provided to connect the power port of the goggles to the goggles battery.

- ⚠ • Only use the DJI goggles battery provided. DO NOT use non-DJI batteries.
- DO NOT use the goggles battery to power other mobile devices.

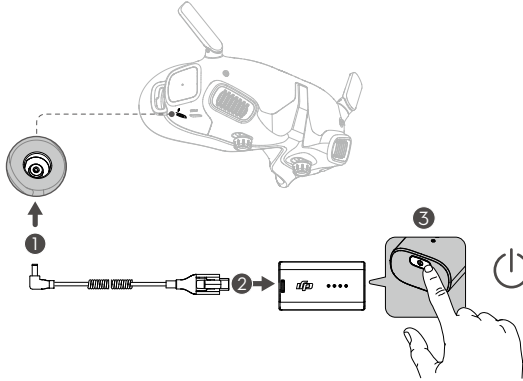

Press the power button once to check the current battery level.

Press once, then press again and hold for two seconds to power the goggles on or off.

It is recommended to use a USB Power Delivery charger to charge the goggles battery if the power level is too low.

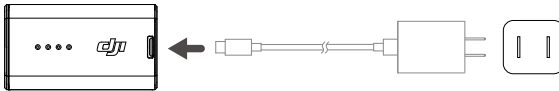

Using the Touch Panel

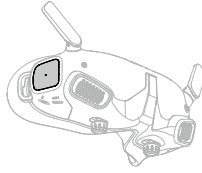

The touch panel enables you to operate with only one hand:

Swipe up from the bottom: enter Camera Settings

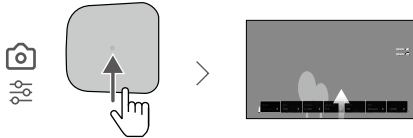

Swipe down from the top: enter Shortcut Menu

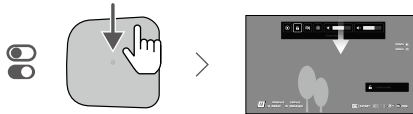

Swipe right from the left: enter Menu

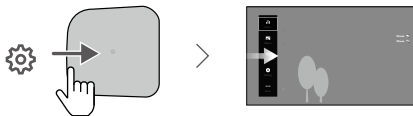

 You can change the settings to enter Menu by swiping left from the right. To make the change, select Settings from the menu and select Control, then select Invert Horizontal Swipe.

Swipe up/down/right/left: navigate the menu

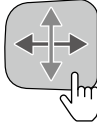

Single tap: confirm/select



Tap with two fingers: back

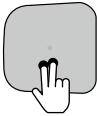

Press and hold with two fingers on the Home Screen: lock/unlock the screen

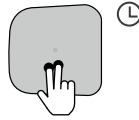

When playing video:

Swipe left/right: control the progress bar

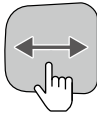

Swipe up/down: adjust volume

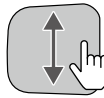

Tap once: pause/play

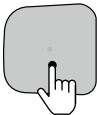

 When operating the touch panel, use slow and precise swipes to maximize function accuracy.

DJI FPV Goggles V2

Diagram

1. Antennas
2. Front Cover
3. Channel Adjustment Buttons
4. Channel Display
5. USB-C Port
6. microSD Card Slot
7. Air Intake
8. Interpupillary Distance (IPD) Slider

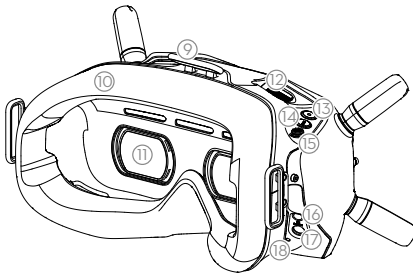
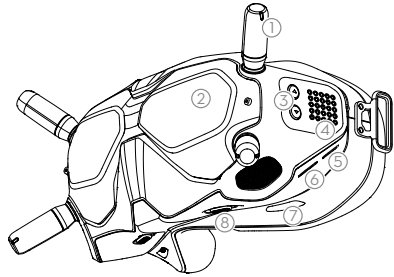

9. Headband Attachment
10. Foam Padding
11. Lens
12. Air Vent
13. Record Button
14. Back Button
15. 5D Button
16. Audio/AV-IN Port
17. Power Port (DC5.5x2.1)
18. Link Button

Installation and Wearing

1. Install the four antennas to the mounting holes on the front of the goggles. Make sure that the antennas are installed securely.

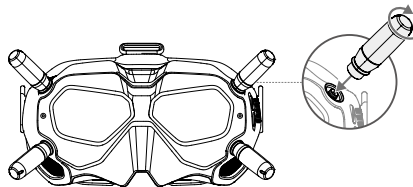

2. Attach the strap to the headband attachment on the top and sides of the goggles.

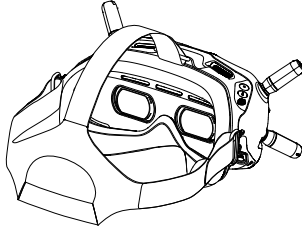

3. Align the lenses over your eyes and pull the headband down. Adjust the headband size until the goggles fit securely and comfortably on your face and head.

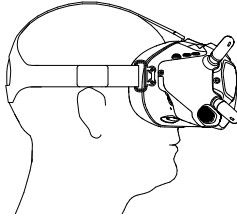

4. Turn the Interpupillary Distance (IPD) slider to adjust the distance between the lenses until the images are properly aligned.

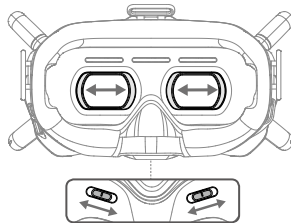

58 – 70 mm

 The goggles can be worn over glasses.

Power Supply

Use the included goggles power cable (USB-C) to connect the power port of the goggles to the goggles battery.

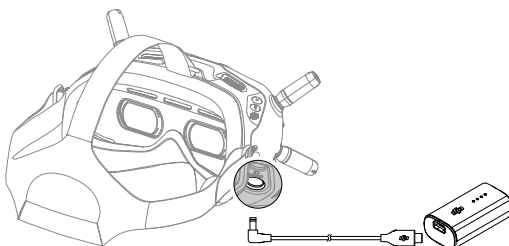

Press the power button once to check the current battery level.

Press once then press again and hold to power the goggles on or off.

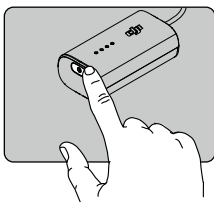

Use a USB Power Delivery charger to charge the goggles battery if the power level is too low.

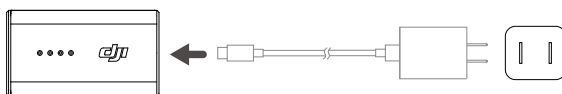

Operation



5D Button

Toggle the button to scroll through the menu. Press the button to confirm.

On the home screen, press the button to enter the menu. Toggle left or right to adjust the screen brightness. Toggle up or down to adjust the volume.



Shutter/Record Button

Press once to take photos or start or stop recording. Press and hold to switch between photo and video mode.



Back Button

Press to return to the previous menu or exit the current mode.

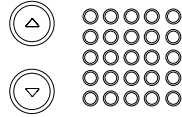

Channel Adjustment Buttons

Press the up or down button to switch channels (only available when in manual channel mode).

Channel Display

Displays the current channel of the goggles.

DJI FPV Remote Controller 2

Diagram



1. Control Sticks
2. Power Button
3. USB-C Port
4. Control Sticks Storage Slot
5. Battery Level LEDs
6. Lanyard Attachment
7. Antennas
8. Shutter/Record Button

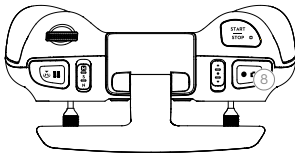

The functions of the dial and other buttons on the remote controller need to be customized by the user.

Preparation

1. Remove the control sticks from the storage slots on the remote controller and screw them into place.
2. Unfold the antennas.

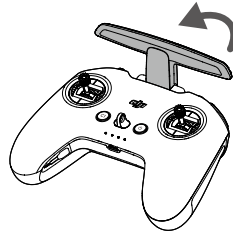
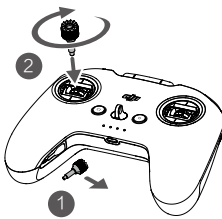

Powering On/Off

Press the power button once to check the current battery level. If the battery level is too low, recharge before use.

Press once then press again and hold to power the remote controller on or off.

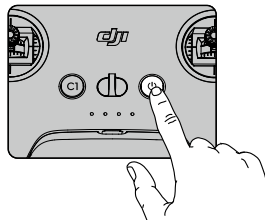

Charging the Battery

Connect the USB-C port of the remote controller to an AC power adapter to charge the remote controller.

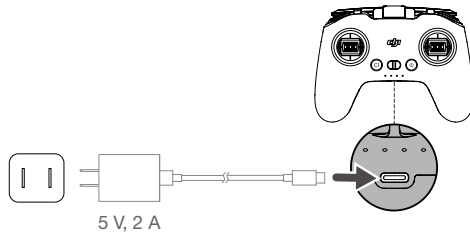

Optimal Transmission Zone

The signal between the aircraft and the remote controller is most reliable when the antennas are positioned in relation to the aircraft as shown below.

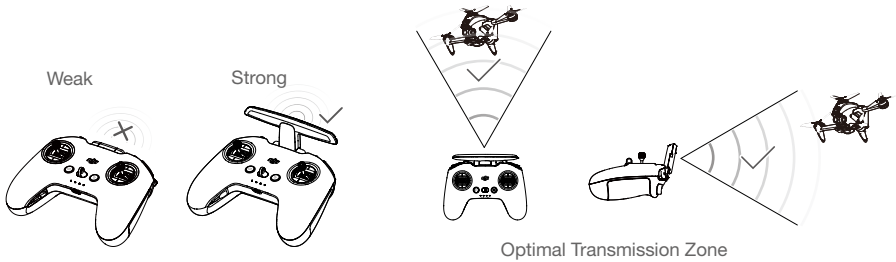

Stick Adjustment

1. Turn the remote controller over and lift the rear rubber grip from the inside groove.

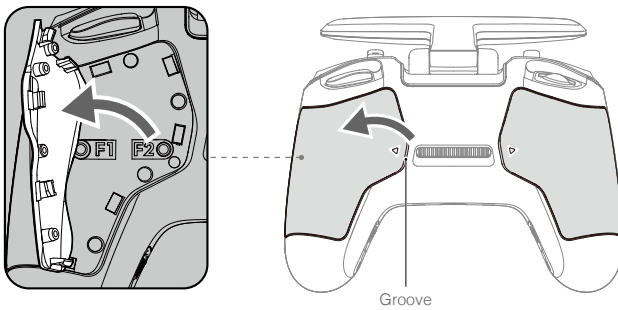

2. Use an H1.5 hex key to adjust the resistance of the stick and recenter the stick vertically. The control resistance increases when the F1 screw is tightened, and the control resistance decreases when the F1 screw is loosened. The recentering is disabled when the F2 screw is tightened, and the recentering is enabled when the F2 screw is loosened.

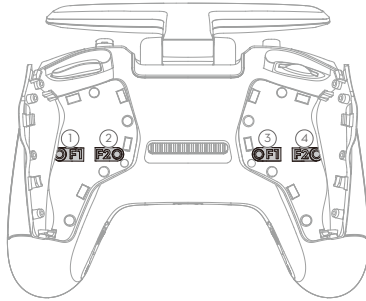

- | | |
|---|--|
| ① F1 Right Stick Resistance Adjustment Screw (Vertical) | ③ F1 Left Stick Resistance Adjustment Screw (Vertical) |
| ② F2 Right Stick Center Adjustment Screw (Vertical) | ④ F2 Left Stick Center Adjustment Screw (Vertical) |

3. Reattach the rubber grip once the adjustment is complete.

Appendix

Specifications

Visit the DJI official website for the latest specifications:

<https://www.dji.com/o3-air-unit/specs>

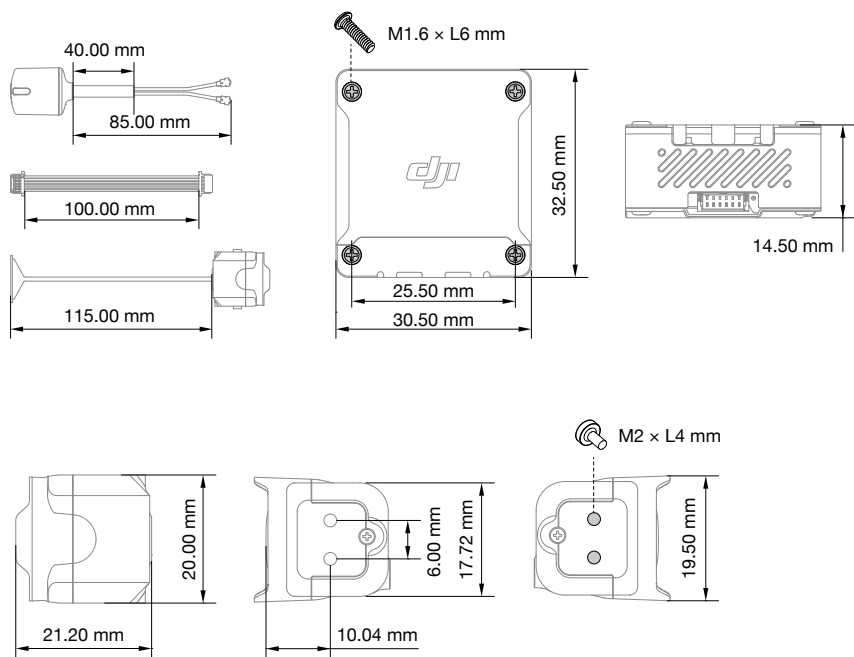

Air Unit

Supported DJI Goggles

DJI Goggles 2
DJI FPV Goggles V2

Supported DJI Remote Controller

DJI FPV Remote Controller 2

Supported Flight Controller Firmware

Compatible with flight controller firmware that supports Betaflight. For more information, check the product FAQ: <https://www.dji.com/o3-air-unit/faq>

Canvas Mode

Support, Betaflight version 4.3.0 or later

	Supports auto mode and manual mode
Channels Info	Manual mode:
	40 MHz: 1 channel: 5794.5 MHz
	20 MHz: 3 channels:
	Channel 1: 5768.5 MHz
	Channel 2: 5804.5 MHz
	Channel 3: 5839.5 MHz
	10 MHz: 3 channels
	Channel 1: 5768.5 MHz
	Channel 2: 5804.5 MHz
	Channel 3: 5839.5 MHz
Operating Temperature	-10° to 40° C (14° to 104°F)
Power Input	7.4 V-26.4 V
Weight	Air unit (camera module included and Dual-Band Dual-Polarized Antenna excluded): Approx. 36.4 g Dual-Band Dual-Polarized Antenna: Approx. 3 g 3-in-1 cable: Approx. 1.2 g
Transmission	O3+
Operating Frequency	2.400-2.4835 GHz (Rx) 5.725-5.850 GHz (Tx/Rx) ^[1]
Transmitter Power (EIRP)	FCC: <33 dBm; SRRC: <30 dBm; CE: <14 dBm
Min. Latency (end-to-end) ^[2]	Used with DJI Goggles 2: 1080p/100fps: 30 ms 1080p/60fps: 40 ms Used with DJI FPV Goggles V2: 810p/120fps: < 28 ms 810p/60fps: < 40 ms
Max. Transmission Distance ^[3]	FCC: <10 km; SRRC: <6 km; CE: <2 km
Storage	Approx. 20 GB
Camera Module	
Image Sensor	1/1.7" CMOS
Lens	Equivalent Focal Length: 12.7 mm
	Focal Length: 2.34 mm
	Aperture: f/2.8
	Focus Mode: FF
	Focus Range: 0.6 m to ∞
Shutter	Rolling shutter
ISO	100-6400 (Auto)
	100-25600 (Manual)

FOV	155°(D)
EIS	Support RockSteady
Supported Video Recording Format	MP4
Video Resolution	<p>Used with DJI Goggles 2: 4K@30/50/60/100/120fps 2.7K@30/50/60/100fps/120fps 1080p@30/50/60/100fps/120fps</p> <p>Used with DJI FPV Goggles V2: 4K@30/50/60/100/120fps 2.7K@30/50/60/100/120fps 1080p@30/50/60/100/120fps</p>
Weight	Approx. 8.3 g (coaxial cable included)
microSD Cards	
Supported microSD Cards	microSD card (Max. capacity 256 GB)
Recommended microSD Cards	Sandisk Extreme U3 V30 A1 32 GB microSDXC Sandisk Extreme Pro U3 V30 A1 32 GB microSDXC Kingston CANVAS GO! Plus U3 V30 A2 64 GB microSDXC Kingston CANVAS React Plus U3 V90 A1 64 GB microSDXC Kingston CANVAS React Plus U3 V90 A1 128 GB microSDXC Kingston CANVAS React Plus U3 V90 A1 256 GB microSDXC Samsung Pro Plus V30 U3 V30 A2 256 GB microSDXC

- [1] The 5.8 GHz frequency band is currently banned in certain countries and regions. For details, please refer to local laws and regulations.
- [2] Tested in an outdoor open environment free of interference. The video transmission latency data varies with different devices.
- [3] Tested in an outdoor open environment free of interference. It should serve only as a reference for the max one-way communication distance without considering RTH. Please pay attention to the RTH prompts during actual flight.

DJI is a trademark of SZ DJI TECHNOLOGY CO., LTD. (abbreviated as "DJI") and its affiliated companies. Names of products, brands, etc., appearing in this document are trademarks or registered trademarks of their respective owner companies.

This content is subject to change without prior notice.

Download the latest version from <https://www.dji.com/o3-air-unit>

If you have any questions about this document, contact DJI by sending a message to DocSupport@dji.com.