

CHASING - CSHF 700WH Battery

User Manual

V1.0

CHASING

www.chasing.com

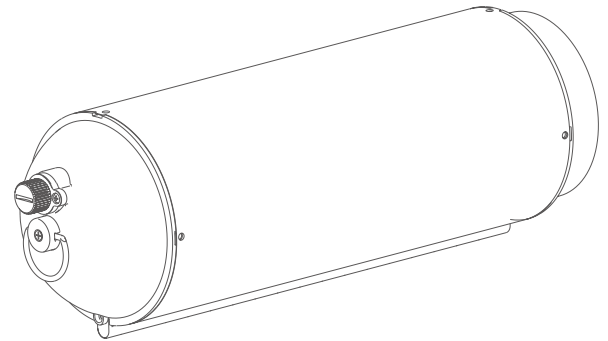

CHASING

Contents

CN 用户手册

01

EN User Manual

05

充放电

1. 充电口

CN

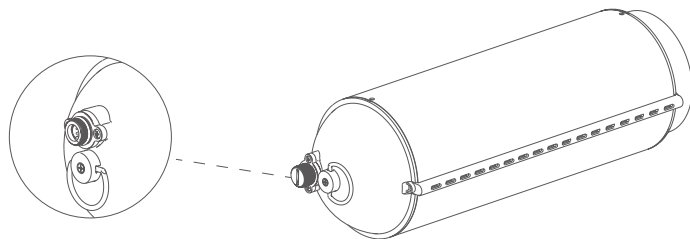

pin定义

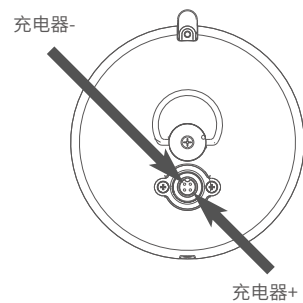

*注意: 充电后下水使用之前一定要先将盖帽拧上拧紧

电池使用连接图

充电

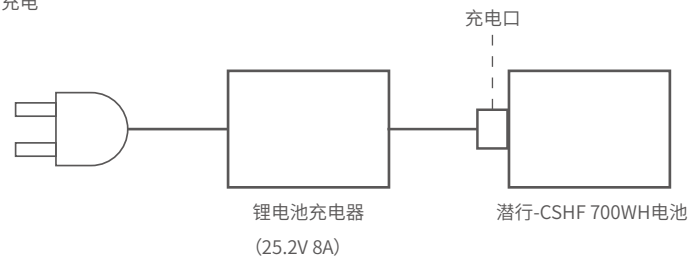

2. 放电口

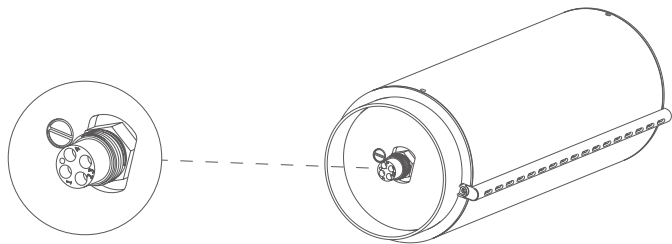

细节图

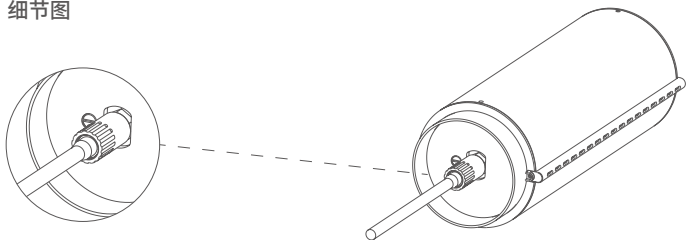

(1) 放电口连接器型号是MCBH4F

(2) 推荐适配公缆型号是MCIL4M

pin定义

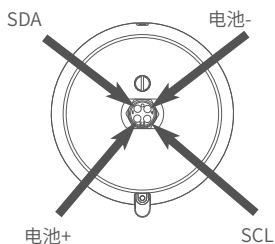

电池使用连接图

放电

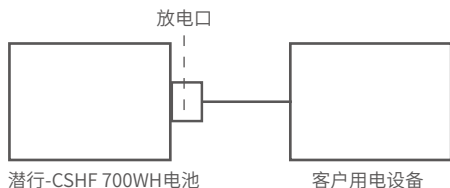

产品参数

700Wh电池舱部件		
参数类型	规格	备注
重量	5030±30g	700WH电池舱部件重量, 不含浮力模块组件和配重块
尺寸	φ120*377mm	700WH电池舱部件尺寸
额定容量	725.76Wh	
额定电压	21.6V	
充电电压	25.2V	
最大充电电流	8A	
充电时间	7.5H@25.2V,8A,25°C	使用潜行25.2V,8A充电器充电时长为7.5H (本数据是实验室测试数据, 不同环境下的充电时长稍有差异)
标准放电温度	-10~60°C	-10°C≤温度≤5°C环境下放电, 电池容量无法完全释放, 温度越低, 无法释放的容量越多
标准充电温度	0~45°C	
标准储存温度	-20~60°C	长期存储时, 请将电量保持为50-70%进行存储, 并且2-3个月进行一次放电、充电, 避免电池亏电。
保护功能	过充保护、过放保护、短路保护、过温保护、过流保护	
电芯化学成分	Li-ion	
锂电池安全使用注意事项	禁止高压充电; 禁止高温使用、充电; 禁止强烈撞击; 禁止接触火源	否则有起火、爆炸风险
最大放电电流	5A	
放电截止电压	17.2V	
通信协议	SMBus	

物品清单

CN

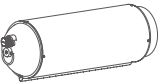
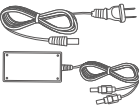
名称	数量	图片
700WH电池舱组件	1	
充电口密封盖 (带密封垫)	1	
充电器&充电线	1	

注意事项

- (1) 严禁将本产品靠近热源,如火源或加热炉;
- (2) 禁止以任何方式拆解或用尖利物体刺破本产品。
- (3) 禁止用导线或其它金属物体致使本产品短路。
- (4) 禁止在本产品上堆放其他重物。

支持

有任何疑问或者技术问题请发送邮件至潜行售后或通过官网客户热线联系我们。

售后客服热线:400-667-6959

售后邮箱地址:support01@chasing-innovation.com--欧洲

support02@chasing-innovation.com --亚洲&大洋洲

support03@chasing-innovation.com-- 南北美洲&非洲

CHASING
潜行创新

本指南如有更新,恕不另行通知。

您可以进入潜行官网查询最新版本: <https://www.chasing.com>

Charging and Discharging

EN

1. Charging port

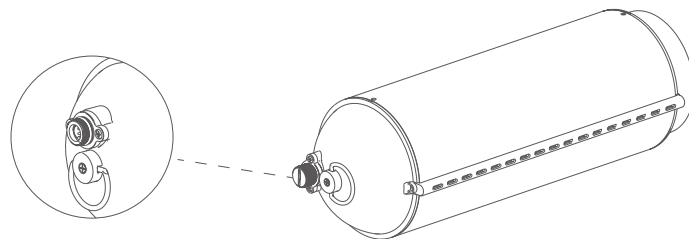

pin definition

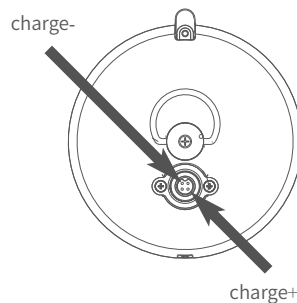

* Note: After charging, please be sure to screw the cap on and tighten it before use

Battery Connection Diagram

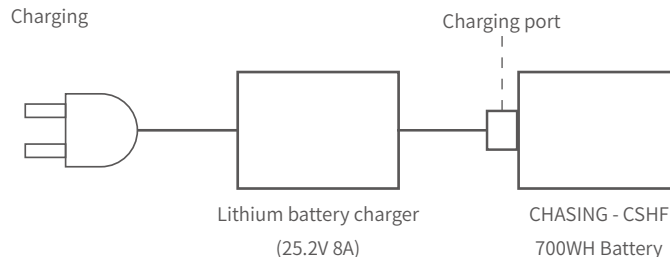

2. Discharging port

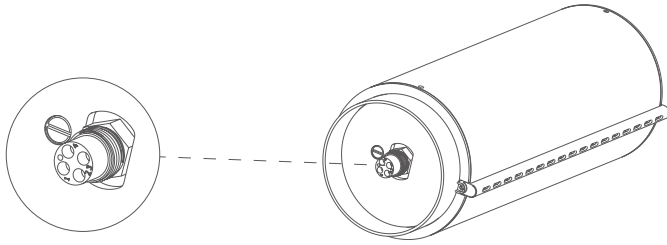

Detail

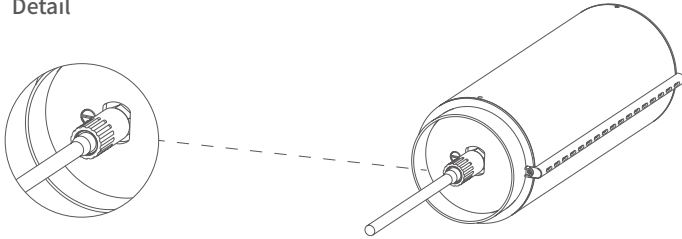

- (1) The model of the discharging port connector is MCBH4F
- (2) The model of the recommended adapter cable is MCIL4M

pin definition

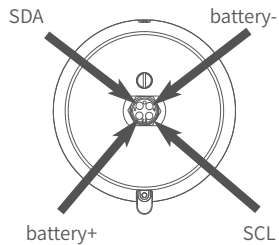

Battery Connection Diagram

Discharging

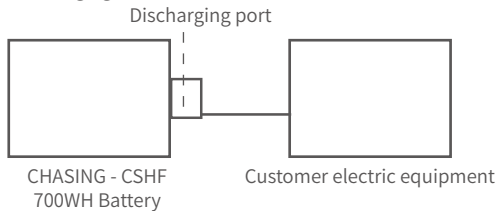



Product Parameters

700Wh Battery Compartment Parts		
Parameter Type	Spec.	Remarks
Weight	5030±30g	The weight of 700Wh battery compartment parts, excluding tether module assemblies and counterweight
Dimension	φ120*377mm	Dimension of 700Wh battery compartment parts
Rated Capacity	725.76Wh	
Rated voltage	21.6V	
Charging voltage	25.2V	
Max. charging current	8A	
Charging time	7.5H@25.2V,8A,25°C	It takes 7.5H for charging with CHASING 25.2V,8A charger (This data is tested in the laboratory, which may vary under different circumstances)
Standard discharging temperature	-10~60°C	When discharging under -10°C-5°C, the battery capacity fails to be fully discharged. The lower the temperature, the more the capacity failing to discharge
Standard charging temperature	0~45°C	
Standard storage temperature	-20~60°C	For long-term storage, keep the battery at 50-70% for storage, and discharge and charge every 2-3 months to avoid lack of electricity.
Protection function	Over-charge protection, over-discharge protection, short-circuit protection, over-temperature protection and over-current protection	
Cell chemical composition	Li-ion	
Precautions for safe use of lithium battery	No high voltage charging; No use or charge at high temperature; No strong impact; No contact with fire	Otherwise, there is a risk of fire an explosion
Maximum discharge current	5A	
End-off voltage	17.2V	
Communication protocol	SMBus	

Packing List

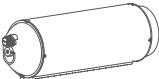
EN

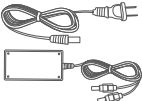
Name	Qty.	Picture
Battery compartment parts (700Wh)	1	
Charging port sealing cover(with gasket)	1	
Charger & Charging cable	1	

Cautions

- (1) It is strictly forbidden to place the product near the heat source, such as fire or heating furnace;
- (2) Do not disassemble or puncture the product with sharp objects in any way.
- (3) Do not use wires or other metal objects to cause short circuit of the product.
- (4) Do not stack other heavy objects on the product.

Support

For any questions or technical problems, please contact us by the Email of CHASING After-Sales Department or the customer service hotline on the official website.

After-sales Service Hotline: 400-667-6959

After-sales Email: support01@chasing-innovation.com--Europe

support02@chasing-innovation.com--Asia & Oceania

support03@chasing-innovation.com--North and South Americas & Africa

CHASING

This Manual is subject to updating without prior notice.

The latest version is available on CHASING official website: <https://www.chasing.com>.